

James Clerk
Maxwell
(1831-1879)

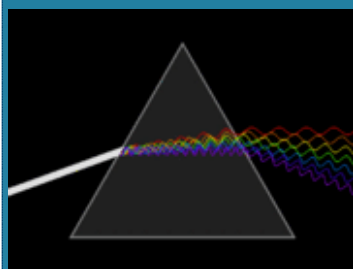

***Can Just Anyone
Understand Maxwell's
Equations, or -
Who's Afraid of
Maxwell's Equations?***



Elya B. Joffe
President - IEEE EMC Society



Celebrating 125 Years
of Engineering the Future

Who's Afraid of Maxwell's Equations?

"From a long view of the history of mankind - seen from, say, ten thousand years from now - there can be little doubt that the most significant event of the 19th century will be judged as Maxwell's discovery of the laws of electrodynamics"

(Richard P. Feynman)

The special theory of relativity owes its origins to Maxwell's equations of the electromagnetic field

(Albert Einstein)

"Maxwell can be justifiably placed with Einstein and Newton in a triad of the greatest physicists known to history"

(Ivan Tolstoy, Biographer)

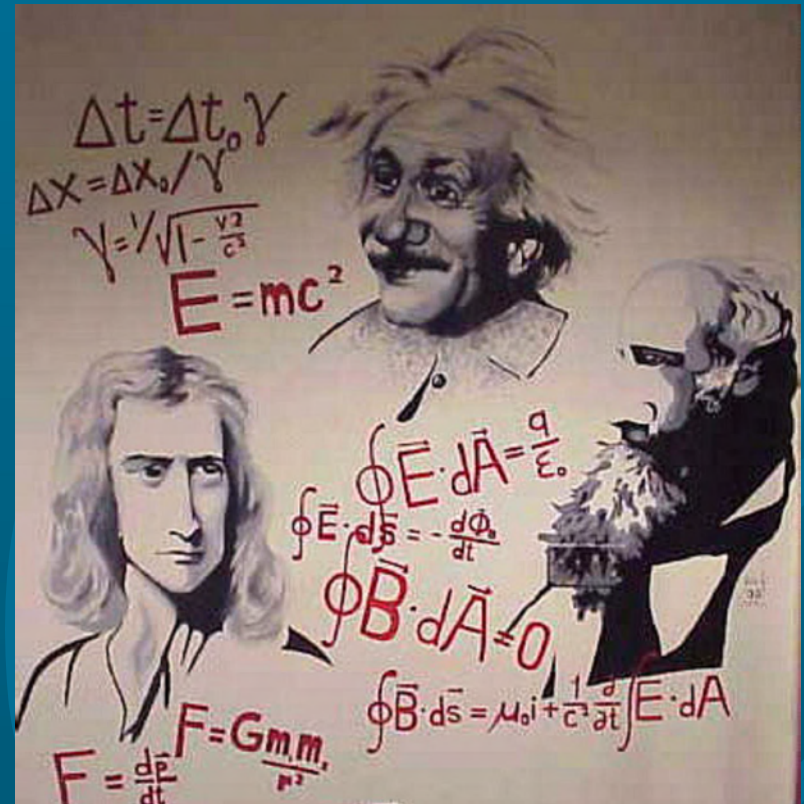

Presentation Outline

1. In the Beginning...

2. “May the Force be with You...”

3. All this Business about ‘them’ fields?

4. Basic Vector Calculus

5. Electrostatics and Magnetostatics

6. Kirchhoff’s Laws

7. Electrodynamics

8. Application of Maxwell’s Equations to Real Life EMC Problems

In the beginning...

- In the beginning, God created the Heaven and the Earth ...

- ... and God Said:

$$\nabla \cdot \vec{D} = \rho$$

$$\nabla \cdot \vec{B} = 0$$

$$\nabla \times \vec{E} = -\frac{\partial \vec{B}}{\partial t}$$

$$\nabla \times \vec{H} = \vec{J} + \frac{\partial \vec{D}}{\partial t}$$

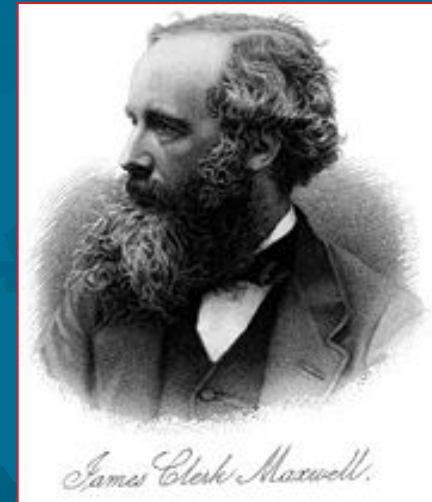

- And there was light!

Introduction

- Electromagnetics can be scary
 - Universities *LOVE* messy math
- EM is not difficult, unless you want to do the messy math
 - EM is complex but not complicated
- Objectives:
 - Intuitive understanding
 - Understand the basic fundamentals
 - Understand how to read the math
 - See "real life" applications



"May the Force be with You..."

- I imagine, just imagine...
 - A force like gravitation, but $\approx 10^{36}$ stronger
 - Two kinds of matter: "positive" and "negative"
 - Like kinds repel and unlike kinds attract...
- There is such a force: **Electrical force**
 - For static charges (Coulomb's Law)
 - With a little imbalance between electrons and protons body of a person - "the force" could lift the Earth
- When charges are in motion, another force occurs:
Magnetic force

- Lorenz's Law: $\vec{F} = q(\vec{E} + \vec{v} \times \vec{B})$

- Superposition of fields:

$$\vec{E} = \vec{E}_1 + \vec{E}_2 + \dots + \vec{E}_n$$

STAR
WARS

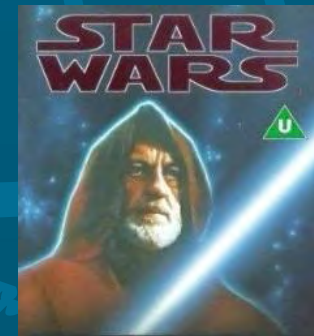

"May the Force be with You..."

- When current flows through a wire and a magnet is moved near the current-carrying wire, the wire will move due to force exerted by the magnet

$$\vec{F}_M = q(\vec{v} \times \vec{B})$$

- *Current = movement of charges*
- *Magnetic fields interact with moving charges*

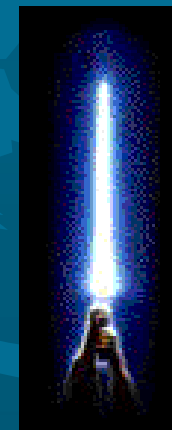
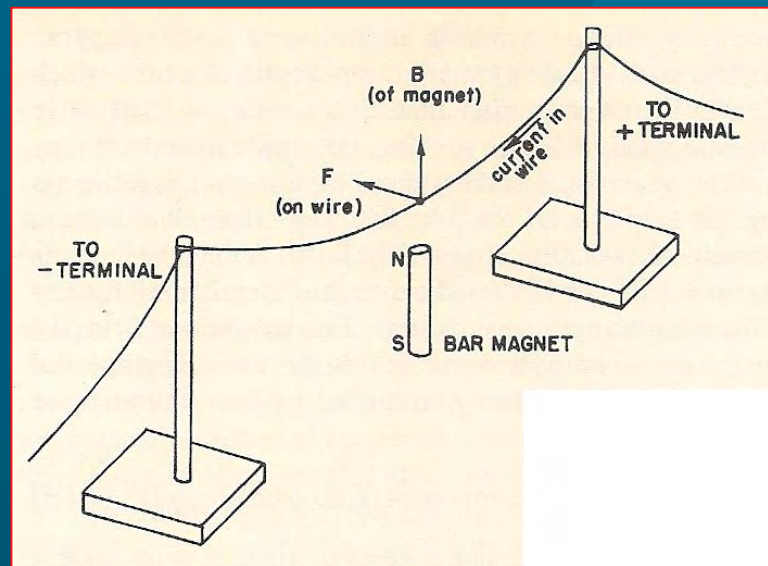
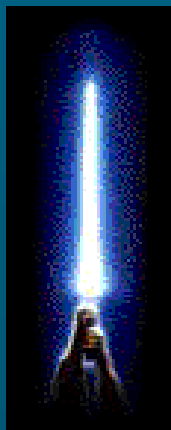

The force is with you...

"May the Force be with You..."

- Current in the wires exerts force on the magnet
 - The magnetic force produced by the wire acts on the static magnet (same as the field produced by a magnet)
 - *Why does it not move?*
 - *Make is light enough and it will*
 - *Try a needle of a compass (you may check this at home...)*

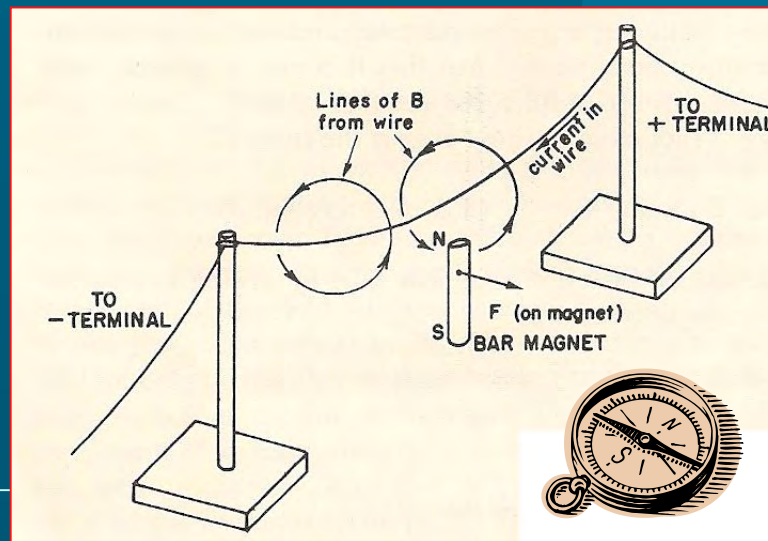

“May the Force be with You...”

- Two wires carrying current exert forces on each other
 - Each produces a magnetic field
 - Each carries current on which the magnetic fields act

$$\vec{F} = q(\vec{E} + \vec{v} \times \vec{B})$$

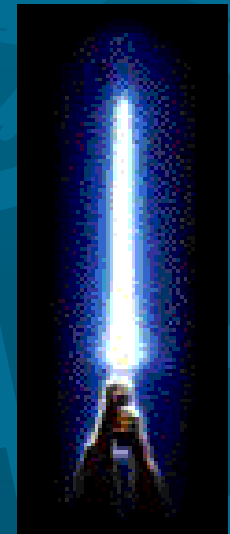
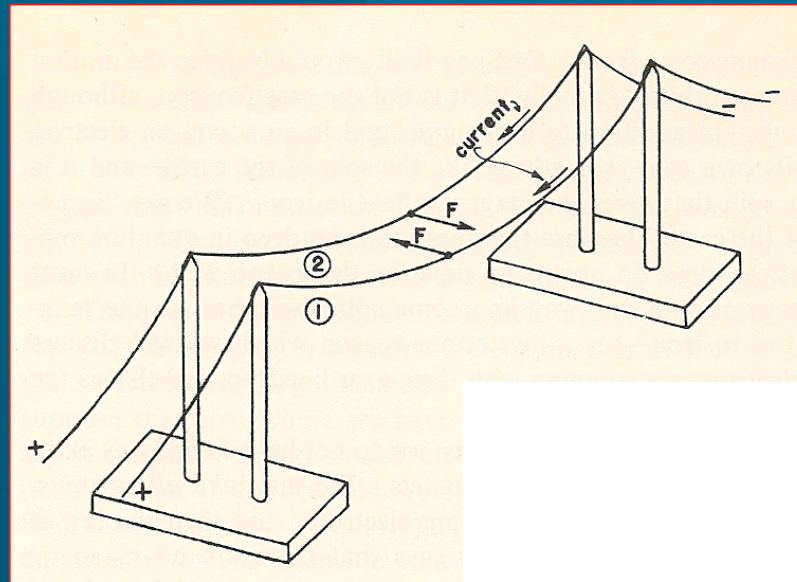

What's All this Business about 'them' fields?

- Fields: Abstract concepts, a figment of imagination...
 - A quantity which depends on position in space
 - e.g., temperature distribution, air pressure in space
 - E and H fields are really tools to determine the force on charged particles,
 - Any charges: E-fields
 - Moving charges: H-fields
 - Represent the force exerted on a charge **assuming** it does not disturb (perturb) the position or motion of nearby charges
- In general, fields vary and are defined in space and time:

$$E = E(x, y, z, t)$$



Scalar and Vector Fields

- Fields can be scalar or vector fields
 - **Scalar fields** are characterized at each point by **one number**, a scalar and may be time-dependent
 - e.g., $T(x,y,z,t)$
 - Represented as contours
 - **Vector fields** have, in addition to value, a **direction of flow and varies from point to point**
 - e.g., flow of heat, velocity of a particle
 - Represented by lines which are tangent to the direction of the field vector at each point
- The density of the lines is proportional to the magnitude of the field

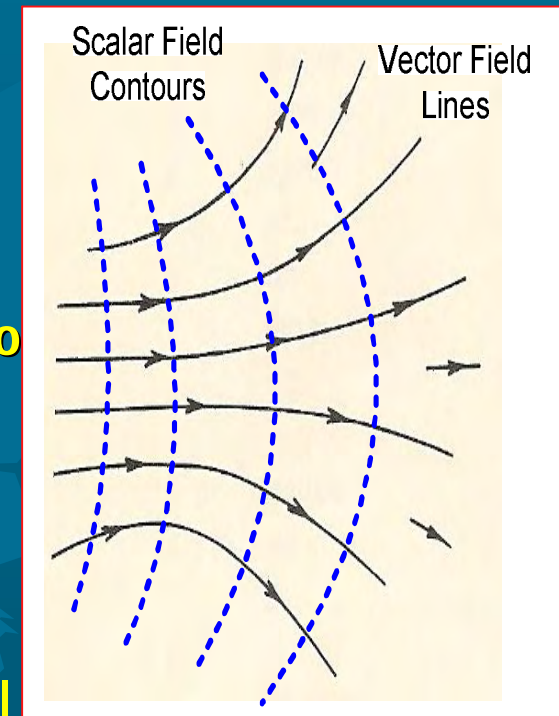

Scalar and Vector Fields

- **Flux:** A quality of "inflow" or "outflow" from a volume
 - e.g., flow of water from a lake into a river
 - Flux = the net amount of (something) going through a closed surface per unit time, or:

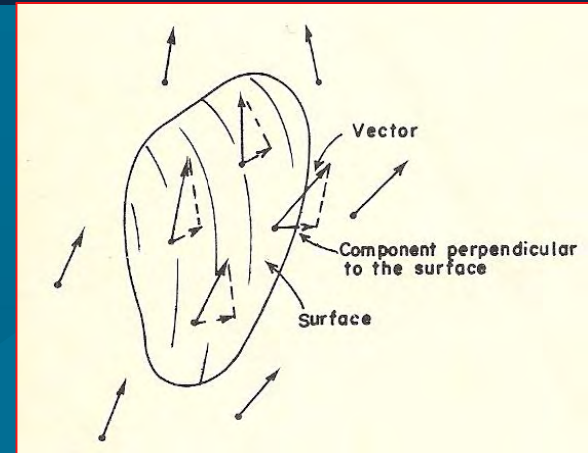

- **Flux = Average component normal to surface ^a surface area**

- **Circulation:** The amount of rotational move, or "swirl" around some loop
 - e.g., flow of water in a whirlpool
 - No physical curve need to exist, any imaginary closed curve will suffice

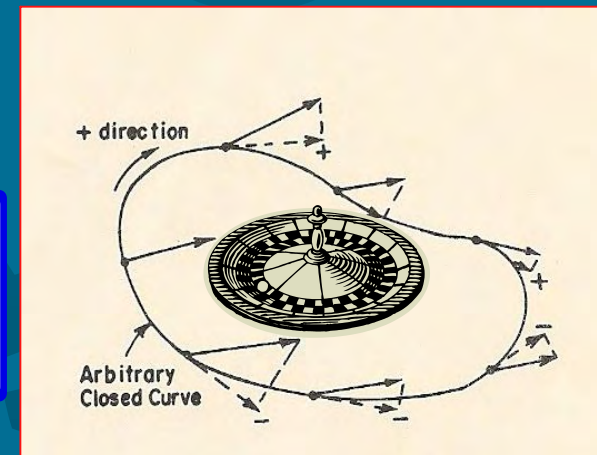

- **Circulation = Average component tangent to curve ^a distance around curve**

- ***All electromagnetism laws are based on flux & circulation***

Basic Vector Calculus

The Del (∇) Operator

- In the 3D Cartesian coordinate system with coordinates (x, y, z) , del (∇) is defined in terms of partial derivative operators as:

$$\nabla = \hat{i} \frac{\partial}{\partial x} + \hat{j} \frac{\partial}{\partial y} + \hat{k} \frac{\partial}{\partial z}$$

- $\{i, j, k\}$ is the standard basis in the coordinate system
- A shorthand form for “lazy mathematicians” to simplify many long mathematical expressions
- Useful in electromagnetics for the **gradient**, **divergence**, **curl** and **directional derivative**
- Definition may be extended to an n-dimensional Euclidean space

Basic Vector Calculus

The Gradient of f (Grad f)

- **Grad f :** The vector derivative of a scalar field f :

$$\text{Grad } f(x, y, z) = \nabla f(x, y, z) = \hat{i} \frac{\partial f}{\partial x} + \hat{j} \frac{\partial f}{\partial y} + \hat{k} \frac{\partial f}{\partial z}$$

- Always points in the direction of greatest increase of f
- Has a magnitude equal to the maximum rate of increase at the point
 - If a hill is defined as a height function over a plane $h(x,y)$, the 2d projection of the gradient at a given location will be a vector in the xy -plane pointing along the steepest direction with a magnitude equal to the value of this steepest slope

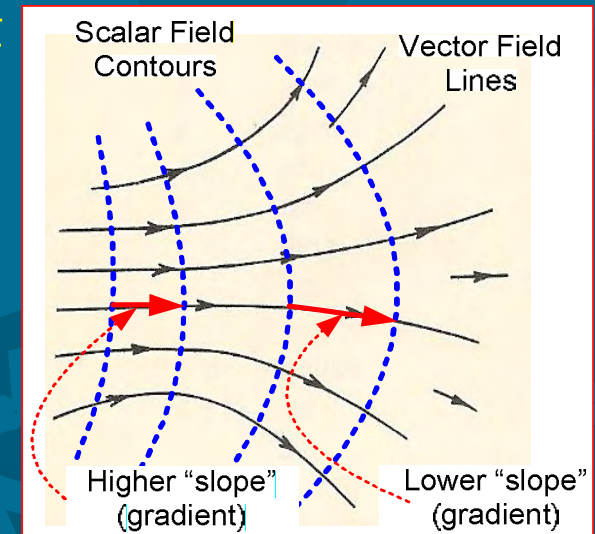

Basic Vector Calculus

The Divergence of \mathbf{f} ($\text{Div } \mathbf{f}$)

- **Div \mathbf{f} :** The scalar quantity obtained from a derivative of a vector field \mathbf{f} :

$$\text{Div } \vec{f}(x, y, z) = \nabla \cdot \vec{f}(x, y, z) = \frac{\partial f_x}{\partial x} + \frac{\partial f_y}{\partial y} + \frac{\partial f_z}{\partial z}$$

- Roughly a measure of the extent a vector field behaves like a source or a sink at a given point
- More accurately a measure of the field's tendency to converge ("inflow") or repel ("outflow") from a given volume
- If the divergence is nonzero at some point, then there must be a source or sink at that position

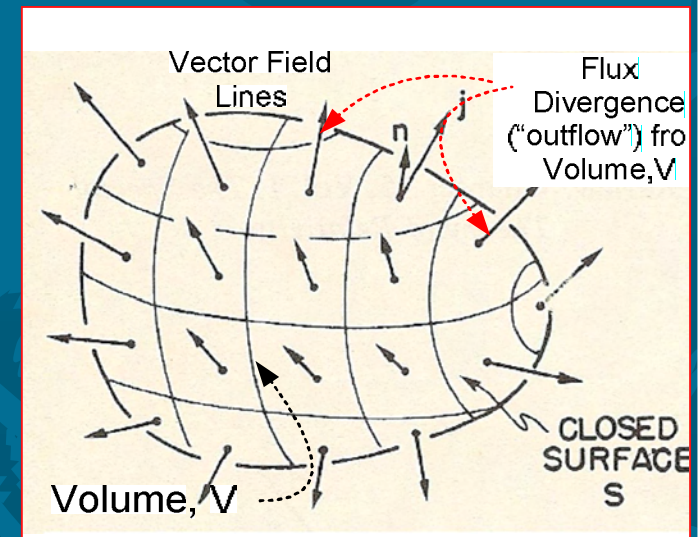

Basic Vector Calculus

The Curl of \mathbf{f} (Curl \mathbf{f})

- **Curl \mathbf{f} :** The vector function obtained from a derivative of a vector field \mathbf{f} :

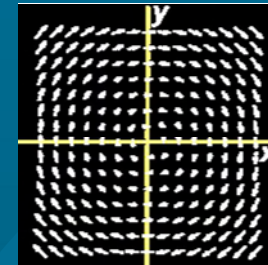

- Specifically:

$$(\nabla \times \vec{f}(x, y, z)) = \hat{i} \left(\frac{\partial f_y}{\partial x} - \frac{\partial f_x}{\partial y} \right) + \hat{j} \left(\frac{\partial f_x}{\partial z} - \frac{\partial f_z}{\partial x} \right) + \hat{k} \left(\frac{\partial f_y}{\partial z} - \frac{\partial f_z}{\partial y} \right)$$

- Roughly a measure of a net circulation (or rotation) density of a vector field at any point about a contour, C
 - The magnitude of the curl tells us how much rotation there is
 - The direction tells us, by the right-hand rule about which axis the field rotates

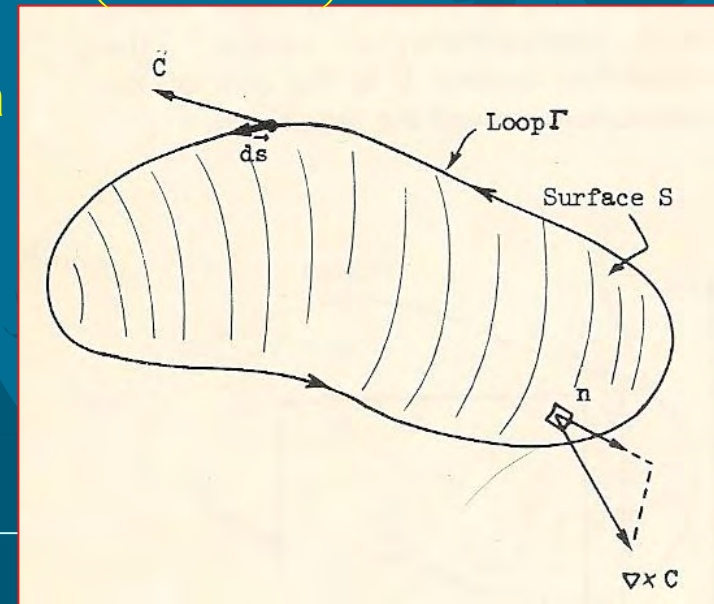

Vector Integration

- Simply the **sum of parts** (when the parts are very small)
 - Line Integral: sum along small line segments
 - Surface Integral: sum across small surface patches
 - Volume Integral: sum through small volume cubes

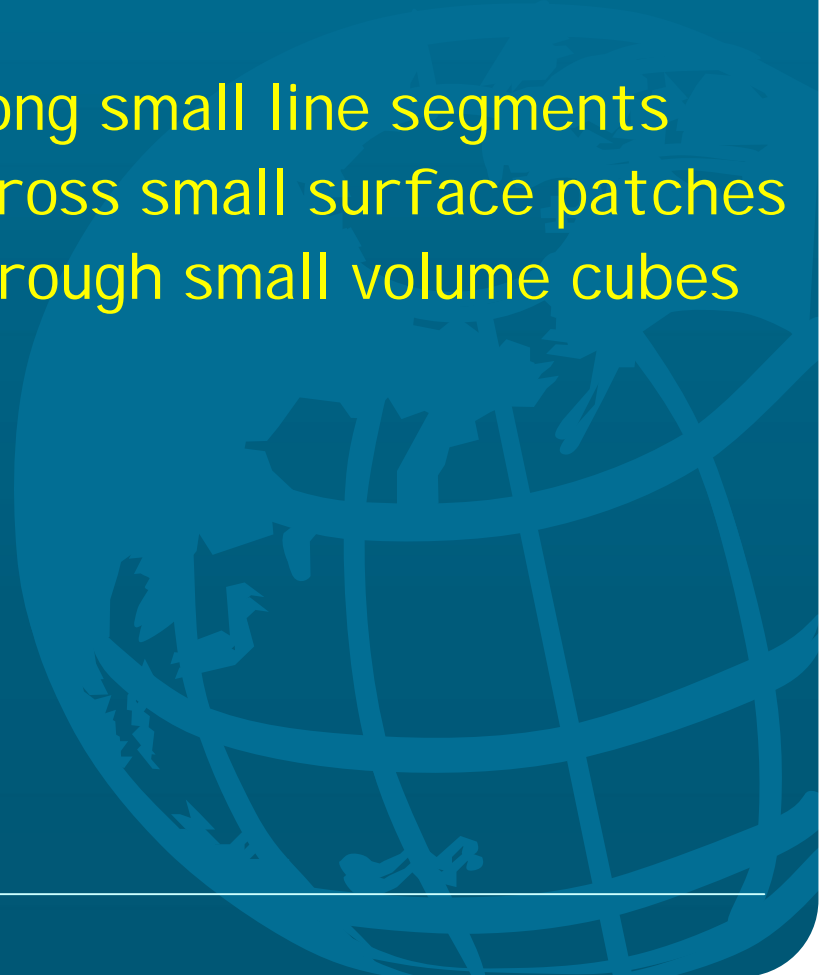

Line Integral

- Finding the sum of projection of the function f along a curve, C

$$\Delta f_x = \frac{\partial f}{\partial x} \cdot \Delta x = \frac{\partial f_x}{\partial x} \Delta x$$

- In general:

$$f(2) - f(1) = \int_{(1)}^{(2)} (\nabla f \cdot ds)$$

- Note that the actual path from (1) to (2) is irrelevant

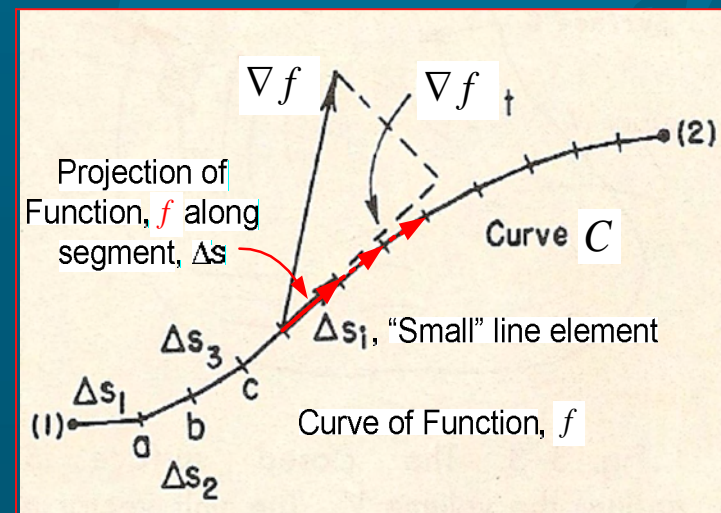
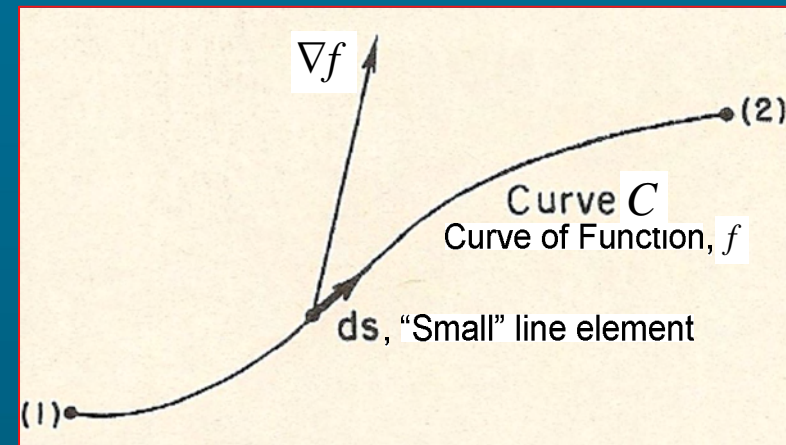

Line Integral around a Closed Contour

- Closed line integrals find the sum of projection of the function f along the circumference of the curve, C

$$f \text{ along contour } C = \oint_C f \cdot ds$$

- This value is not-necessarily zero

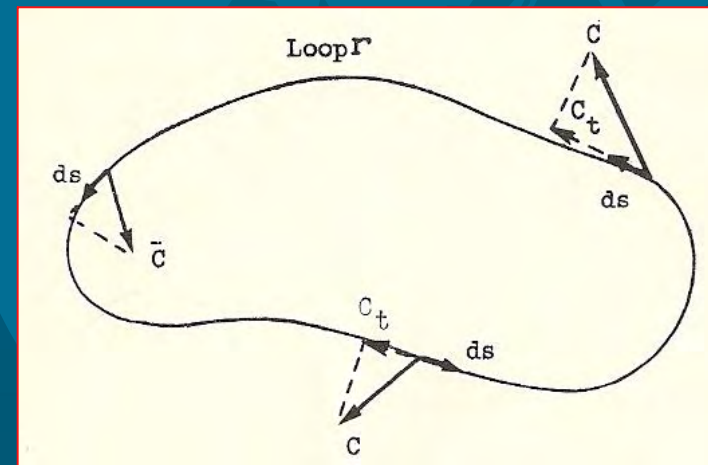

Surface Integral

- Finding the sum of flux of the vector function *flowing outward through and normal to surface, S*

$$\Delta f_n = \frac{\partial f}{\partial a} \cdot \Delta a = \frac{\partial f_n}{\partial a} \Delta a$$

- In general:

$$\Delta f_n = (f \cdot n) \Delta a$$

- Note that n is the vector normal to the surface and the direction of the surface vector a

$$\text{Total outflow of } f \text{ through } S = \int_S f \cdot da$$

- Note: Outflow=Flux

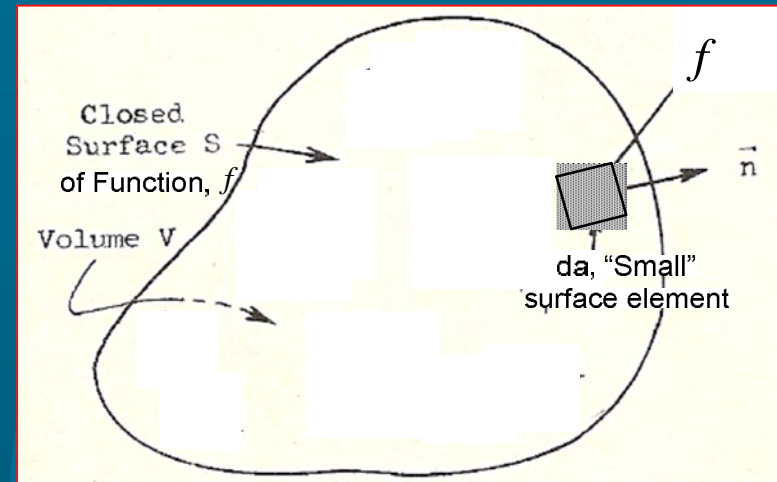

Volume Integral

- Finding a total quantity *within a volume, V* , given its distribution within the volume

$$\Delta f_v = \frac{\partial f}{\partial v} \Delta V$$

- Note in practice this is typically a **scalar** value

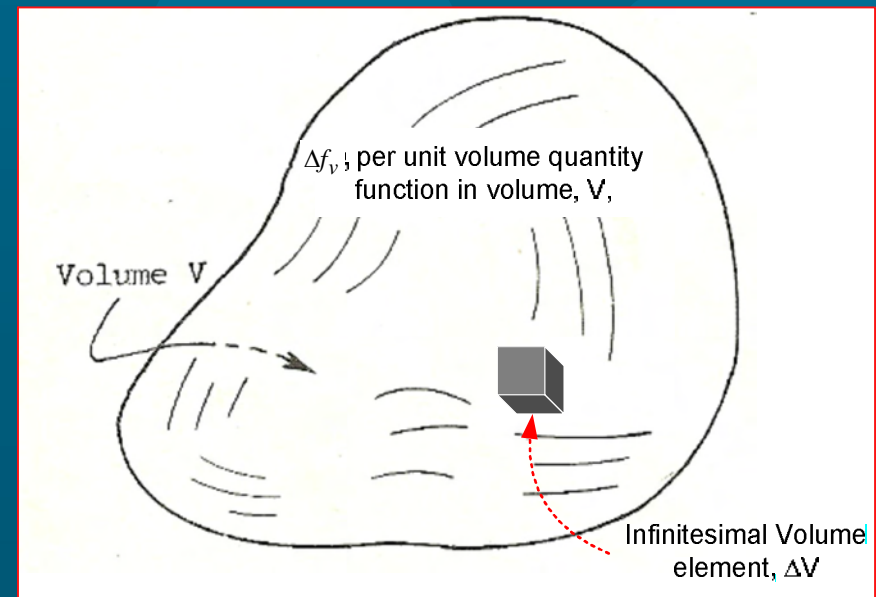

Divergence (Gauss) theorem

- Volume integral of the divergence of a vector equals total outward flux of vector through the surface that bounds the volume

$$\int_V (\nabla \cdot \vec{f}) dV = \oint_S \vec{f} \cdot d\vec{a}$$

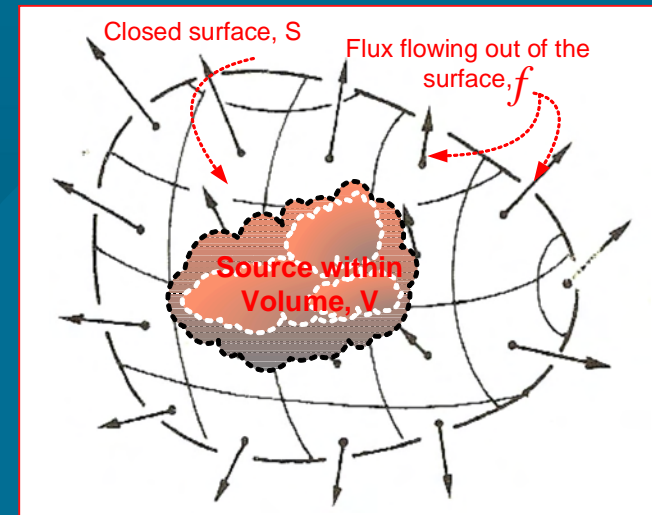
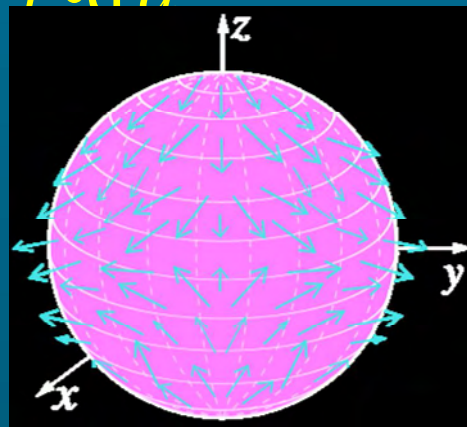

- The divergence theorem is thus a conservation law stating that the volume total of all sinks and sources, the volume integral of the divergence, is equal to the net flow across the volume's boundary
 - Implying that for flux to occur from a volume there must be sources enclosed within the surface enclosing that volume
 - The flux from the volume diminishes whatever was within that volume, if its conservation must occur

Stokes' theorem

- Surface integral of the **curl** of a vector field over an open surface is equal to the **closed line integral** of the **vector** along the contour bounding the surface

$$\int_S (\nabla \times \vec{f}) \cdot d\vec{a} = \oint_C \vec{f} \cdot d\vec{s}$$

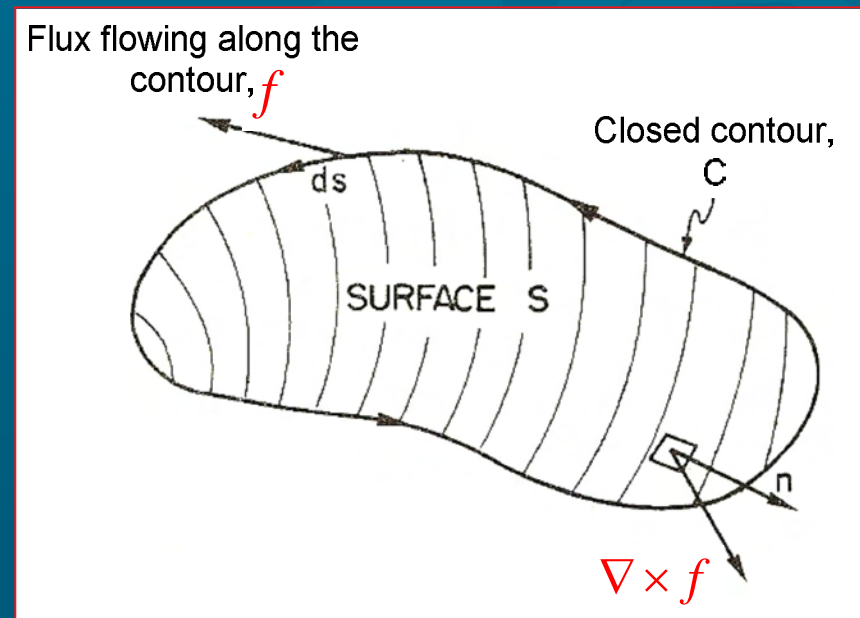

- Implying that certain sources create circulating flux in a plane perpendicular to the flow of the flux

Curl-Free Fields

- If everywhere in space $\nabla \times \vec{f} \equiv 0$ it follows from Stokes' theorem that the circulation must also be zero

$$\int_S (\nabla \times \vec{f}) \cdot d\vec{a} = \oint_C \vec{f} \cdot d\vec{s} \equiv 0$$

- Therefore, regardless of the path:

$$\int_{(1)}^{(2)} \vec{f} \cdot d\vec{s} = - \int_{(2)}^{(1)} \vec{f} \cdot d\vec{s}$$

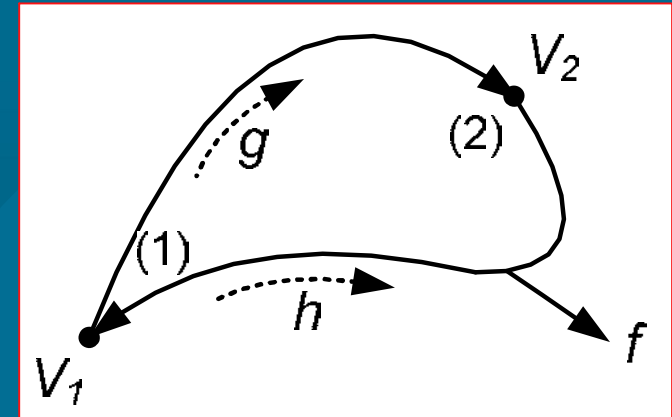

- Therefore, the integral depends on position only
- The concept of **potential** is born!
 - The field, f , must be a gradient of this potential, $\vec{f} = \nabla V(x, y, z)$; $V = \text{scalar}$
 - Thus... $\nabla \times (\nabla V) \equiv 0$

Maxwell's Field Equations

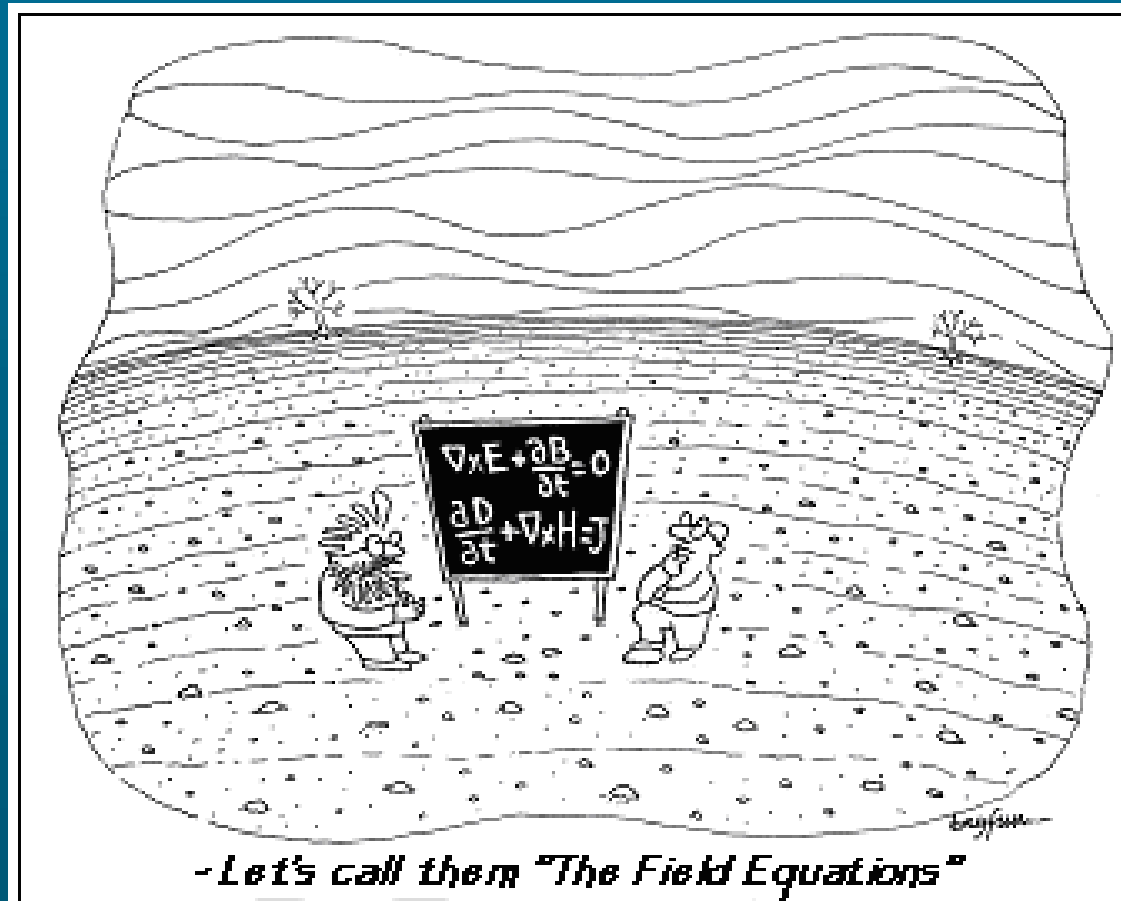

Maxwell's Equations

Maxwell's Equations in Differential and Integral Forms

$$\nabla \cdot \vec{D} = \rho$$

 \Rightarrow

Gauss's Theorem

$$\oint_S \vec{D} \cdot d\vec{s} = \int_V \rho dv$$

$$\nabla \cdot \vec{B} = 0$$

 \Rightarrow

$$\int_V (\nabla \cdot \vec{f}) dv = \oint_S \vec{f} \cdot d\vec{a}$$

$$\oint_S \vec{B} \cdot d\vec{s} = 0$$

$$\nabla \times \vec{E} = -\frac{\partial \vec{B}}{\partial t}$$

 \Rightarrow

Stokes' Theorem

$$\oint_C \vec{E} \cdot d\vec{l} = -\int_S \frac{\partial \vec{B}}{\partial t} \cdot d\vec{s}$$

$$\nabla \times \vec{H} = \vec{J} + \frac{\partial \vec{D}}{\partial t}$$

 \Rightarrow

$$\int_S (\nabla \times \vec{f}) \cdot d\vec{a} = \oint_C \vec{f} \cdot d\vec{s}$$

$$\oint_C \vec{H} \cdot d\vec{l} = \int_S \left(\vec{J} + \frac{\partial \vec{D}}{\partial t} \right) \cdot d\vec{s}$$

Laws of Electromagnetism, 1

- Flux of \vec{E} through a closed surface = net charge inside the volume

$$\nabla \cdot \vec{E} = \frac{\rho}{\epsilon}$$

$$\nabla \cdot \vec{D} = \rho; \quad \vec{D} = \epsilon \vec{E}$$

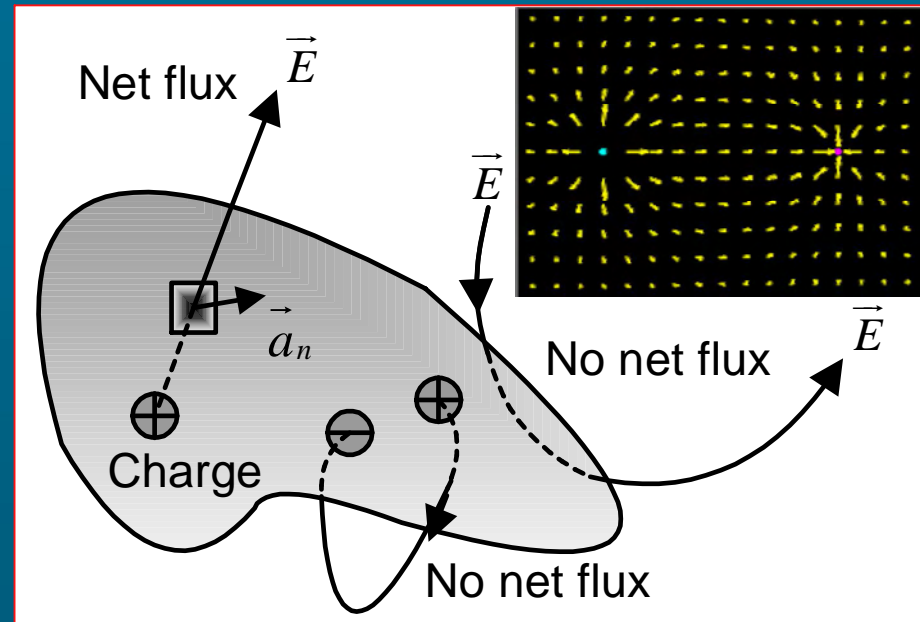

- If there are **no charges inside** the volume, no net charge can emerge out of it
- Adjacent charges will create flux, which enters and leaves the volume, producing zero net flux

Laws of Electromagnetism, 2

- Circulation of \vec{E} around a closed curve = net change of B through the surface

$$\nabla \times \vec{E} = -\frac{\partial \vec{B}}{\partial t}$$

Faraday's Law

- If there are no magnetic fields, or only static magnetic fields are present, the circulation is zero
- Only magnetic fields flowing **through** the surface will produce circulation

"Going to the south and circling to the north the wind goes round and round; and the wind returns on its circuit"

(Ecclesiastes 1:6)

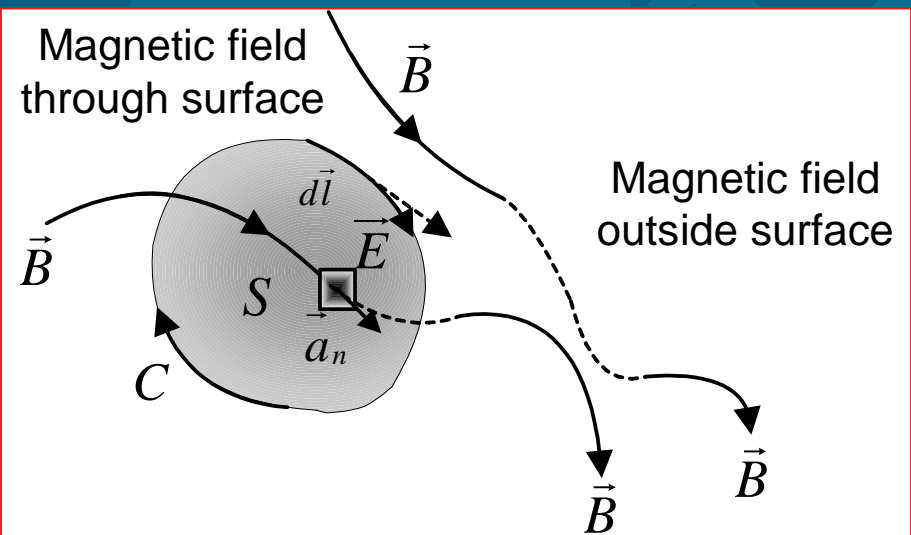

Laws of Electromagnetism, 3

- Flux of B through a closed surface = 0

$$\nabla \cdot \vec{B} = 0$$

- *There are no magnetic charges*

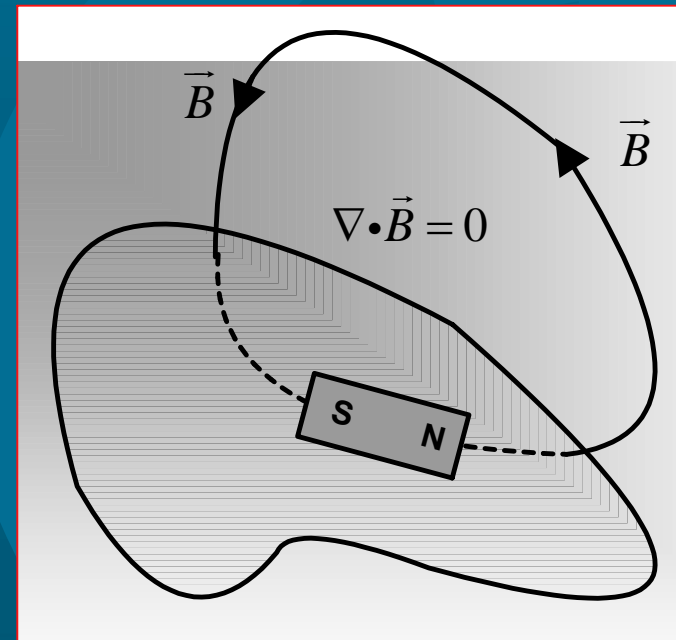

Laws of Electromagnetism, 4

- Circulation of B around a closed curve = net change of E or flux of current through surface

Amper e's Law $\nabla \times \vec{H} = \vec{J} + \frac{\partial \vec{D}}{\partial t}; \vec{B} = \mu \vec{H}$

- Only net current or change of E -field through surface produces circulation of B

"All the rivers flow to the sea, but the sea is not full"

(Ecclesiastes 1:7)

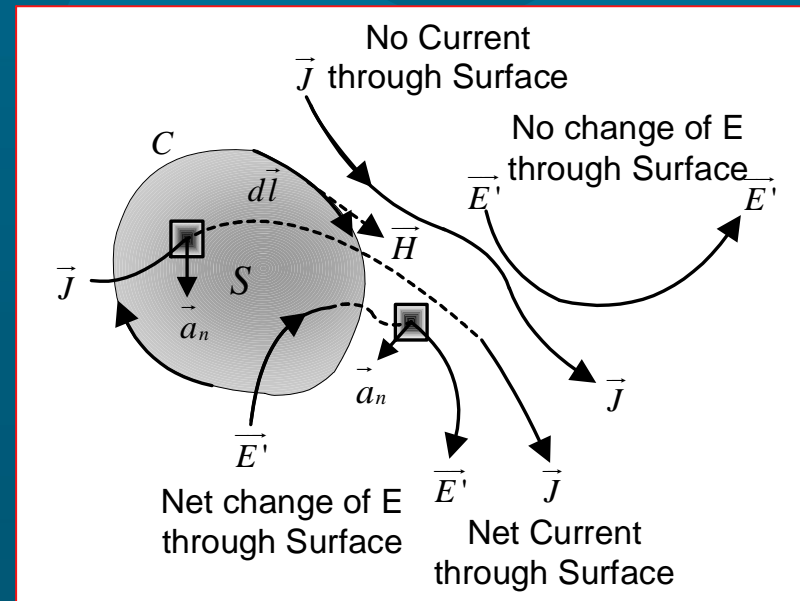
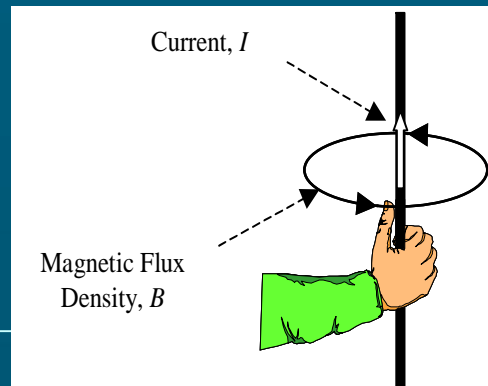

Electrostatics and Magnetostatics

- In electrostatics and magnetostatics, fields are invariant

$$\nabla \cdot \vec{D} = \rho$$

\Rightarrow
Gauss's Law

$$\oint_S \vec{D} \cdot d\vec{s} = \int_V \rho dv$$

$$\nabla \times \vec{E} = 0$$

\Rightarrow
Faraday's Law

$$\oint_C \vec{E} \cdot d\vec{l} = 0$$

Electrostatics

$$\nabla \cdot \vec{B} = 0$$

\Rightarrow
Gauss's Law

$$\oint_S \vec{B} \cdot d\vec{s} = 0$$

$$\nabla \times \vec{H} = \vec{J}$$

\Rightarrow
Ampere's Law

$$\oint_C \vec{H} \cdot d\vec{l} = \int_S \vec{J} \cdot d\vec{s}$$

Magnetostatics

- The equations appear to be decoupled
- E-field and H-field seem independent of each other

Electrostatics

Electrical Scalar Potential

- If $\nabla \times \vec{E} = 0$ we can define $\vec{E} = -\nabla V$
 - The (scalar) electrostatic potential
 - The E-field can be computed everywhere from the potential
- The physical significance: The **potential energy** which a **unit charge** would have if brought to a specified point (2) in space from some reference point (1):

- Work:

$$W = - \int_{(1)}^{(2)} \vec{F} \cdot d\vec{s} = -q \left(\int_{(1)}^{(2)} \vec{E} \cdot d\vec{s} \right) = -q \left(\int_{(1)}^{(2)} \nabla V \cdot d\vec{s} \right) \Rightarrow$$

$$\frac{W}{q} = -[V(2) - V(1)]$$

- independent of path taken, thus $\oint \vec{E} \cdot d\vec{s} \equiv 0$

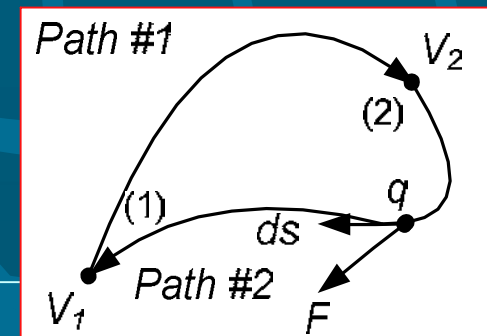

Magnetostatics

Conservation of Charge

- Current must always flow in closed loops:

$$\nabla \times \vec{H} = \vec{J} + \frac{\partial \vec{D}}{\partial t}$$

- Taking the Divergence...

$$\nabla \cdot \nabla \times \vec{H} = \nabla \cdot \left(\vec{J} + \frac{\partial \vec{D}}{\partial t} \right) = \nabla \cdot \vec{J} = -\nabla \cdot \left(\frac{\partial \vec{D}}{\partial t} \right)$$

- But... $\nabla \cdot \nabla \times \vec{H} \equiv 0$ so... $\nabla \cdot \vec{J} = -\nabla \cdot \left(\frac{\partial \vec{D}}{\partial t} \right)$

- In magnetostatics $\frac{\partial \vec{D}}{\partial t} = 0 \Rightarrow \nabla \cdot \vec{J} = 0$

so current must flow in closed loops!

- And... $\int_V (\nabla \cdot \vec{J}) dV = \int_V \left(\nabla \cdot \left(\frac{\partial \vec{D}}{\partial t} \right) \right) dV = \int_V \left(\frac{\partial \rho}{\partial t} \right) dV = \frac{\partial Q}{\partial t} = \dots$

- Conservation of Charge:** $-\frac{\partial \rho}{\partial t} = \nabla \cdot \vec{J} \dots = \oint_s \vec{J} \cdot d\vec{a} = I$

$$\nabla \cdot \nabla \times \vec{H} \equiv 0$$

$$\oint_s \vec{H} \cdot d\vec{s} = 0$$

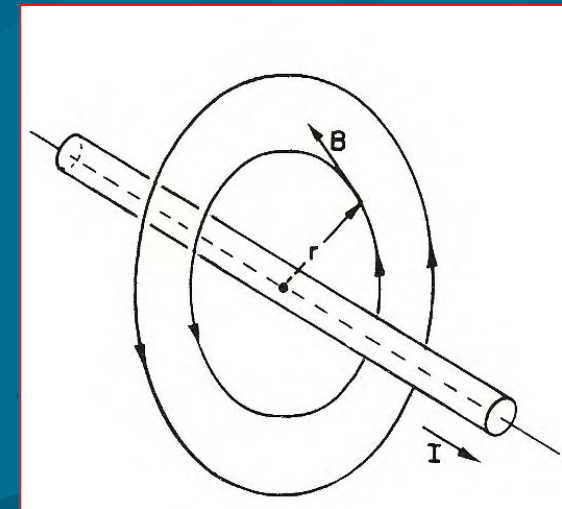

Kirchhoff's Laws

- Kirchhoff's Equations are **approximations**
 - No time-varying fields ($\partial D/\partial t=0$, $\partial B/\partial t=0$)
 - Electrically small circuits
 - ⇒ Quasi-static approximations apply

Conservation of Difficulty: If it is difficult in Maxwell's Equations, it will probably be difficult as an Kirchhoff's-equivalent circuit, but perhaps more intuition will be gained

"Things should be made as simple as possible, but not any simpler "

(Albert Einstein)



Kirchhoff's Current Law (KCL)

- An approximation from Ampere's Law
- When **no time-varying electric fields** are present (electrostatics)

$$\frac{\partial \vec{D}}{\partial t} = 0 \Rightarrow \oint_C \vec{H} \cdot d\vec{l} = \int_S \vec{J} \cdot d\vec{s} = \sum_i I_i$$

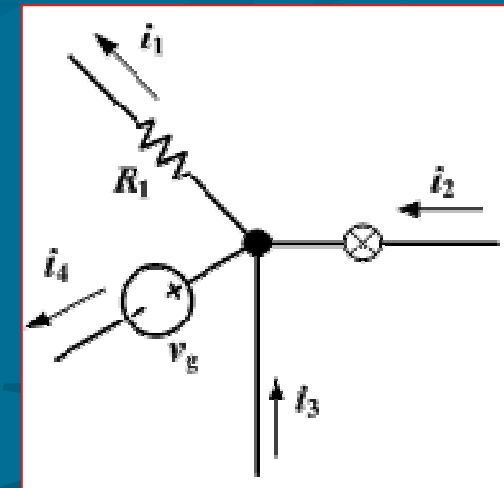

Contour C \rightarrow 0

$$\oint_C \vec{H} \cdot d\vec{l} = \sum_{i=1}^3 I_i = 0$$

Kirchhoff's Voltage Law (KVL)

- When **no time-varying magnetic fields** are present (magnetostatics)

$$\oint_C \vec{E} \cdot d\vec{l} = 0$$

$$\frac{\partial \vec{B}}{\partial t} = 0 \Rightarrow \oint_C \vec{E} \cdot d\vec{l} = \sum_i U_{z_i} - U_{in} = 0$$

Contour - C

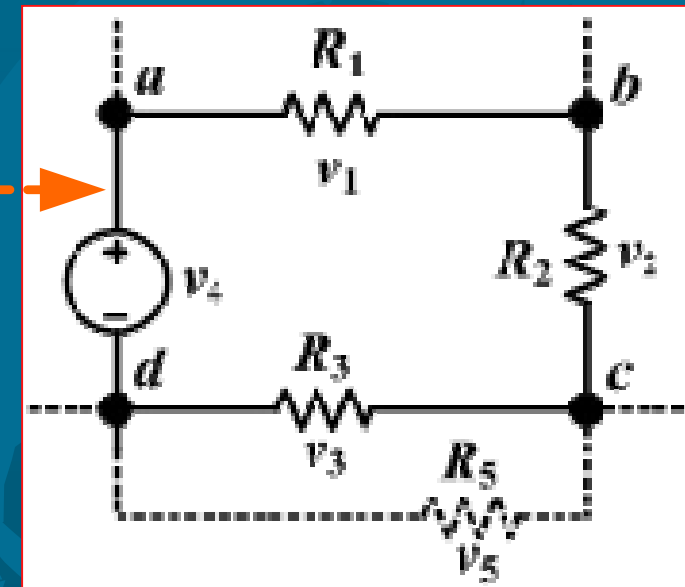

Maxwell's Equations - Electrodynamics

Maxwell's Equations in Differential and Integral Forms

$$\nabla \cdot \vec{D} = \rho$$

Gauss's Law

\Rightarrow

Gauss's Theorem

$$\oint_S \vec{D} \cdot d\vec{s} = \int_V \rho dv$$

$$\nabla \cdot \vec{B} = 0$$

Gauss's Law

\Rightarrow

$$\int_V (\nabla \cdot \vec{f}) dv = \oint_S \vec{f} \cdot d\vec{a}$$

$$\oint_S \vec{B} \cdot d\vec{s} = 0$$

$$\nabla \times \vec{E} = -\frac{\partial \vec{B}}{\partial t}$$

Faraday's Law

\Rightarrow

Stokes' Theorem

$$\oint_C \vec{E} \cdot d\vec{l} = -\int_S \frac{\partial \vec{B}}{\partial t} \cdot d\vec{a}$$

$$\nabla \times \vec{H} = \vec{J} + \frac{\partial \vec{D}}{\partial t}$$

Ampere's Law

\Rightarrow

$$\int_S (\nabla \times \vec{f}) \cdot d\vec{a} = \oint_C \vec{f} \cdot d\vec{s}$$

$$\oint_C \vec{H} \cdot d\vec{l} = \int_S \left(\vec{J} + \frac{\partial \vec{D}}{\partial t} \right) \cdot d\vec{a}$$

Maxwell's Equations - Electrodynamics

Something is Wrong Here... The Missing Link

- In the time-varying case, Maxwell initially considered the following 4 postulates:

$$\nabla \times \vec{E} = -\frac{\partial \vec{B}}{\partial t} \quad (1)$$

$$\nabla \times \vec{H} = \vec{J} \quad (2)$$

$$\nabla \cdot \vec{D} = \rho \quad (3)$$

$$\nabla \cdot \vec{B} = 0 \quad (4)$$

- Or in integral form:

$$\oint_c \vec{E} \cdot d\vec{l} = -\oint_s \frac{d\vec{B}}{dt} \cdot d\vec{a} \quad (1)$$

$$\oint_s \vec{H} \cdot d\vec{l} = I \quad (2)$$

$$\oint_s \vec{D} \cdot d\vec{a} = Q \quad (3)$$

$$\oint_s \vec{B} \cdot d\vec{a} = 0 \quad (4)$$

- But some things seemed wrong:
 - What if the circuit contained a capacitor...?
 - How could electromagnetic radiation occur?

Maxwell's Equations - Electrodynamics

Something is Wrong Here... **The Problem**

- Taking Divergence of (2)

$$\nabla \cdot (\nabla \times \vec{H}) = \nabla \cdot \vec{J}$$

- But from the null identity ...

$$\nabla \cdot (\nabla \times \vec{H}) = \nabla \cdot \vec{J} = 0$$

- This appears to be inconsistent with the principle of conservation of charge and the Equation of Continuity:

$$\nabla \cdot \vec{J} = -\frac{\partial \rho}{\partial t}$$

- Therefore, this equation had to be modified...



(from Gauss Law)

$$\nabla \cdot (\nabla \times \vec{H}) - \frac{\partial \rho}{\partial t} = \nabla \cdot \vec{J} \quad \text{or} \quad \nabla \cdot (\nabla \times \vec{H}) = \nabla \cdot \vec{J} + \frac{\partial \nabla \cdot \vec{D}}{\partial t} = \nabla \cdot \left(\vec{J} + \frac{\partial \vec{D}}{\partial t} \right)$$

- Hence J.C. Maxwell proposed to change (2) to:

$$\nabla \times \vec{H} = \vec{J} + \frac{\partial \vec{D}}{\partial t}$$

Maxwell's Equations - Electrodynamics

Something is Wrong Here... **Displacement Current..**

- Maxwell called the term $\frac{\partial \vec{D}}{\partial t}$ **displacement current density**
 - showing that a time-varying E field ($D=\epsilon E$) can give rise to a H field, even in the absence of current

$$\vec{J} = \rho \vec{v} + \sigma \vec{E}$$

$$\vec{v} = \frac{1}{\sqrt{\mu\epsilon}}$$

Speed of Light

Convection current density
due to the motion of free-
charges

Conduction current
density in conductor
(Ohm's law)

- *Displacement often accounts for **Common Mode Currents***

Maxwell's Equations - Electrodynamics

Something was Wrong... The Link Fixed

- In the time-varying case, Maxwell initially considered the following 4 postulates:

$$\nabla \times \vec{E} = -\frac{\partial \vec{B}}{\partial t} \quad (1)$$

$$\nabla \times \vec{H} = \vec{J} + \frac{\partial \vec{D}}{\partial t} \quad (2)$$

$$\nabla \cdot \vec{D} = \rho \quad (3)$$

$$\nabla \cdot \vec{B} = 0 \quad (4)$$

- Or in integral form:

$$\oint_C \vec{E} \cdot d\vec{l} = -\oint_S \frac{d\vec{B}}{dt} \cdot d\vec{a} \quad (1)$$

$$\oint_C \vec{H} \cdot d\vec{l} = \int_A \left(\vec{J} + \frac{\partial \vec{D}}{\partial t} \right) \cdot d\vec{a} \quad (2)$$

$$\oint_S \vec{D} \cdot d\vec{a} = Q \quad (3)$$

$$\oint_S \vec{B} \cdot d\vec{a} = 0 \quad (4)$$

- Displacement concept added: $\partial \vec{D} / \partial t$

- The only "real" contribution of J. C. Maxwell
- Supports EM radiation:
 - Time varying E-field/Displacement produces time varying H/B-Fields
 - Time varying H/B-Fields produce time varying E-field/Displacement
 - How does lightning current flow?

Maxwell's Equations - Electrodynamics

Radiation: Source-free Wave Equations

- Assume a wave is traveling in a simple non-conducting source-free ($\sigma=0$) medium $\vec{J} = 0, \rho = 0$

- We therefore have:
$$\begin{aligned}\nabla \times \vec{E} &= -\mu \frac{\partial \vec{H}}{\partial t} & \nabla \times \vec{H} &= \epsilon \frac{\partial \vec{E}}{\partial t} \\ \nabla \cdot \vec{E} &= 0 & \nabla \cdot \vec{H} &= 0\end{aligned}$$

- Differentiating: $\nabla \times \nabla \times \vec{E} = -\mu \frac{\partial}{\partial t} (\nabla \times \vec{H}) = -\mu \frac{\partial}{\partial t} \left(\epsilon \frac{\partial \vec{E}}{\partial t} \right) = -\mu \epsilon \frac{\partial^2 \vec{E}}{\partial t^2}$

- The equations are coupled! Re-writing -

$$\nabla \times \nabla \times \vec{E} + \mu \epsilon \frac{\partial^2 \vec{E}}{\partial t^2} = 0$$

- but for a source free environment:-

$$\nabla \times \nabla \times \vec{E} = \nabla (\nabla \cdot \vec{E}) - \nabla^2 \vec{E} = \nabla (0) - \nabla^2 \vec{E} = -\nabla^2 \vec{E}$$

Maxwell's Equations - Electrodynamics

Radiation: Source-free Wave Equations

- This results in a simple equation:

$$\nabla \times \nabla \times \vec{E} = \nabla(\nabla \cdot \vec{E}) - \nabla^2 \vec{E} = -\nabla^2 \vec{E} \quad \& \quad \nabla \times \nabla \times \vec{E} + \underbrace{\mu\epsilon}_{\downarrow} \frac{\partial^2 \vec{E}}{\partial t^2} = 0$$

- EM Wave Velocity (speed of light):

$$v = \frac{1}{\sqrt{\mu\epsilon}}$$

- So, we obtain:

- Electric Field Wave Equation: $\nabla^2 \vec{E} - \frac{1}{v^2} \frac{\partial^2 \vec{E}}{\partial t^2} = 0$ Homogeneous vector wave equations
- Magnetic Field Wave Equation: $\nabla^2 \vec{H} - \frac{1}{v^2} \frac{\partial^2 \vec{H}}{\partial t^2} = 0$

- Radiation results from coupling of Maxwell's Equations:

- Ampere's Law
- Faraday's Law

See?! - It is not **that** complicated!

Maxwell's Equations - Electrodynamics

Radiation: Source-free Wave Equations

- Electromagnetic waves can be imagined as a self-propagating transverse oscillating wave of electric and magnetic fields

$$\nabla \times \vec{E} = -\mu \frac{\partial \vec{H}}{\partial t}$$

$$\nabla \times \vec{H} = \varepsilon \frac{\partial \vec{E}}{\partial t}$$

- This diagram shows a plane linearly polarized wave propagating from left to right
- The electric field is in a vertical plane, the magnetic field in a horizontal plane.

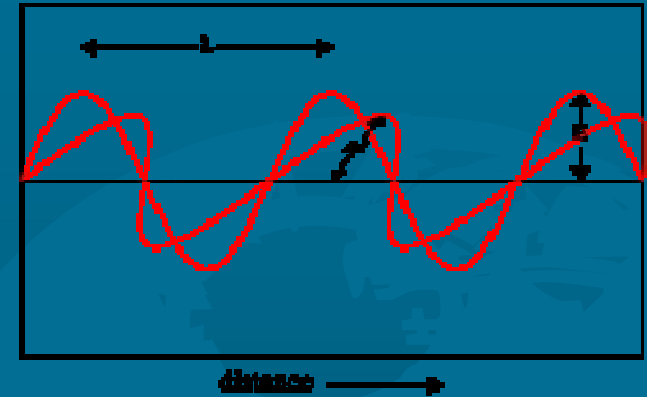
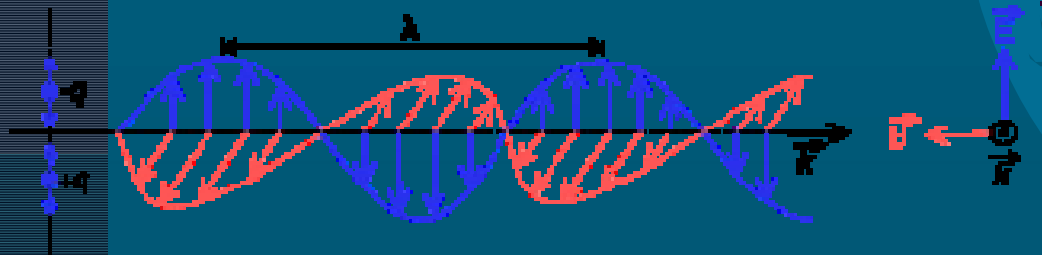

- A time-varying E-field generates a H-field and vice versa

- An oscillating E-field produces an oscillating H-field, in turn generating an oscillating E-field, etc...
- forming an EM wave

Evolution of Electrodynamics

Relativity

Electrodynamics

Circuit theory



Application of Maxwell's Equations to Real Life EMC Problems

Good Ol' Max's Equations

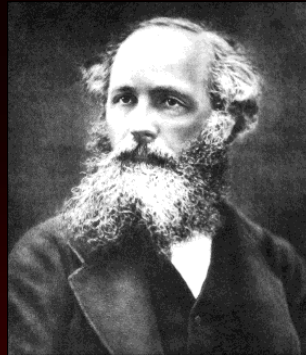

Path of
Current
Return

Balanced
Wire
Pairs

Twisted
Wire
Pairs

Return
Current
Flow on
PCBs

Visualize Return Currents...

- Currents always return...
 - To ground??
 - To battery negative??

LOOK

- Where are they?
 - They are all here... flowing back to their source!!



Where will the return current flow?

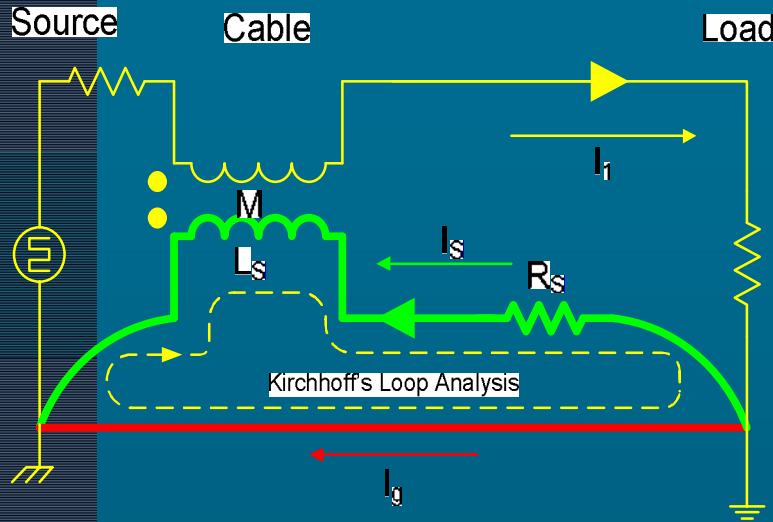

Equivalent Circuit

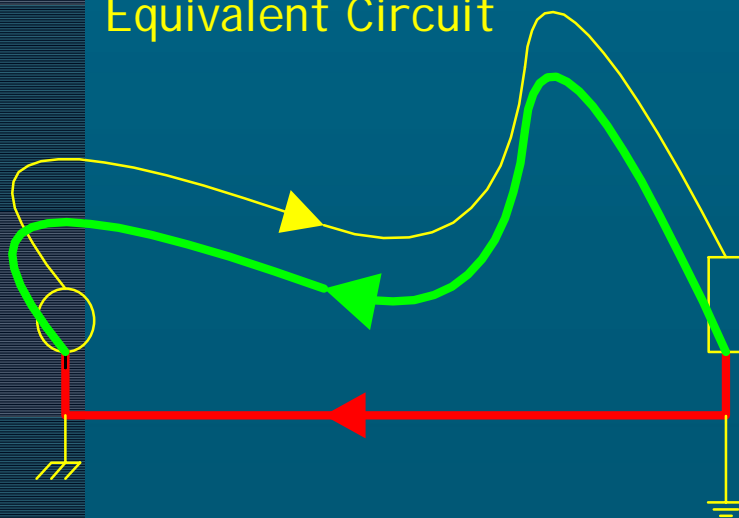

$$I_s \cdot (R_s + j\omega L_s) - I_l \cdot j\omega M = 0$$

$$\downarrow L_s = M$$

$$\frac{I_s}{I_l} = \frac{j\omega L_s}{R_s + j\omega L_s}$$

$$I_g \ll I_l, I_s \rightarrow I_l \Leftrightarrow \omega \gg \frac{R_s}{L_s}$$

$$I_s \gg I_g \Leftrightarrow \omega \gg \frac{R_s}{L_s}$$

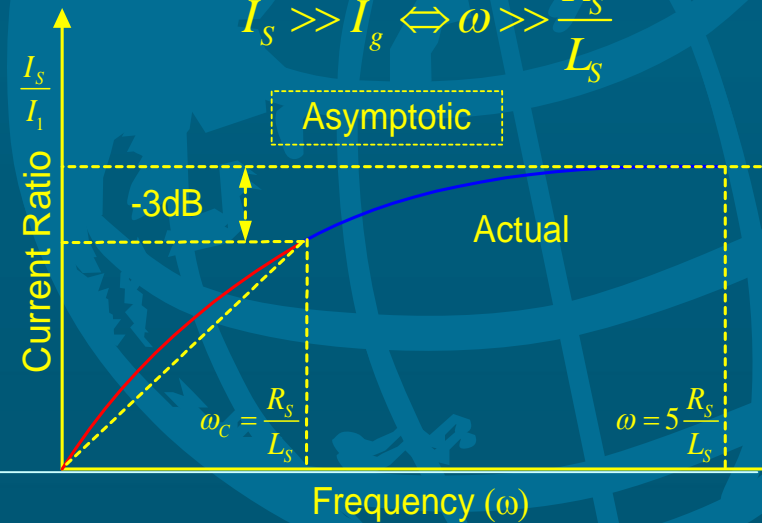

Where will the return current flow?

- At LOWER FREQUENCIES, the current follows the path of LEAST RESISTANCE, via ground (I_g)

$$Z = R_s + j\omega \cdot M \stackrel{\omega \rightarrow 0}{=} \begin{cases} |Z| \approx R_s & @ R_s \gg j\omega \cdot L_s \\ |Z| \approx \omega \cdot L_s & @ \omega \cdot L_s \gg R_s \end{cases} \quad I_s = I_1 \cdot \frac{j\omega}{R_s/L_s + j\omega} \approx 0$$

- At HIGHER FREQUENCIES, the current follows the path of LEAST INDUCTANCE, via ground (I_g)

$$Z = R_s + j\omega \cdot M \stackrel{\omega \rightarrow 0}{=} \begin{cases} |Z| \approx R_s & @ R_s \gg j\omega \cdot L_s \\ |Z| \approx \omega \cdot L_s & @ \omega \cdot L_s \gg R_s \end{cases} \quad I_s = I_1 \cdot \frac{j\omega}{R_s/L_s + j\omega} \approx 0$$

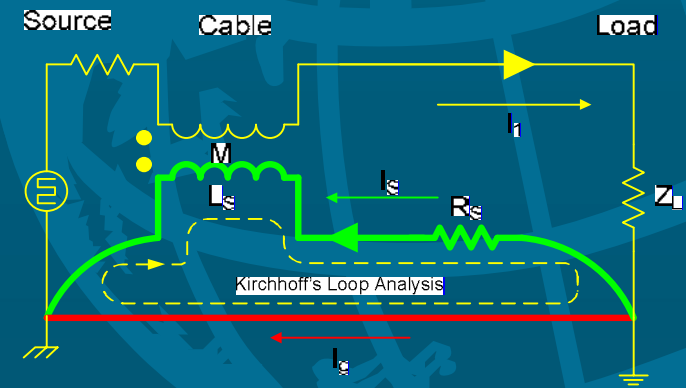
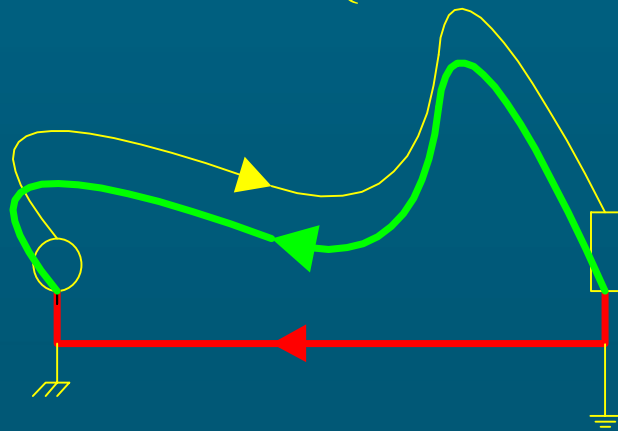

Where will the return current flow?

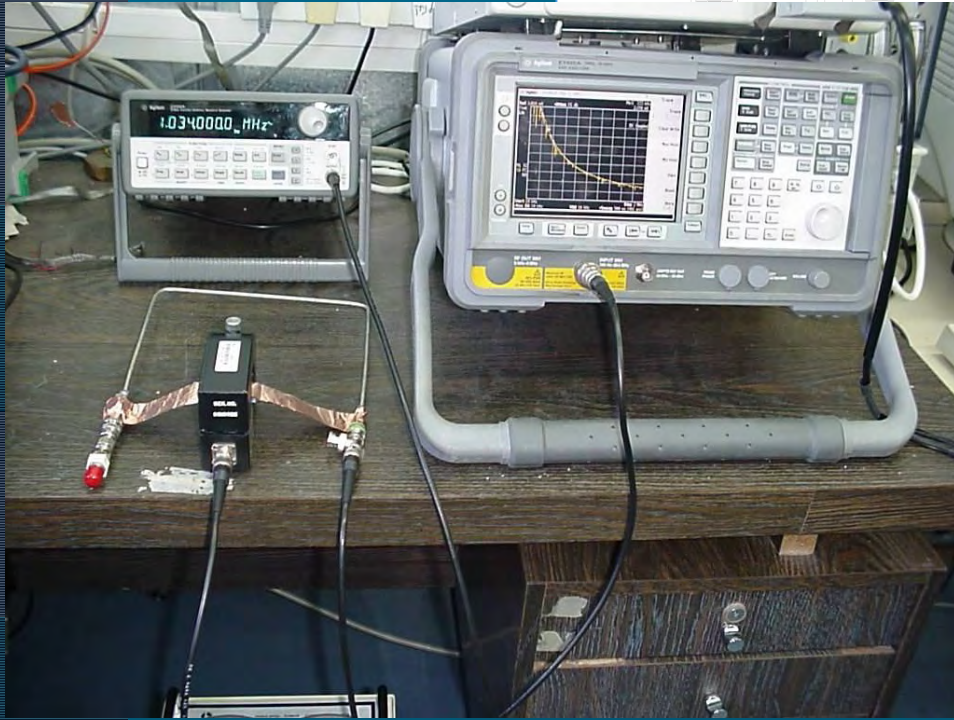
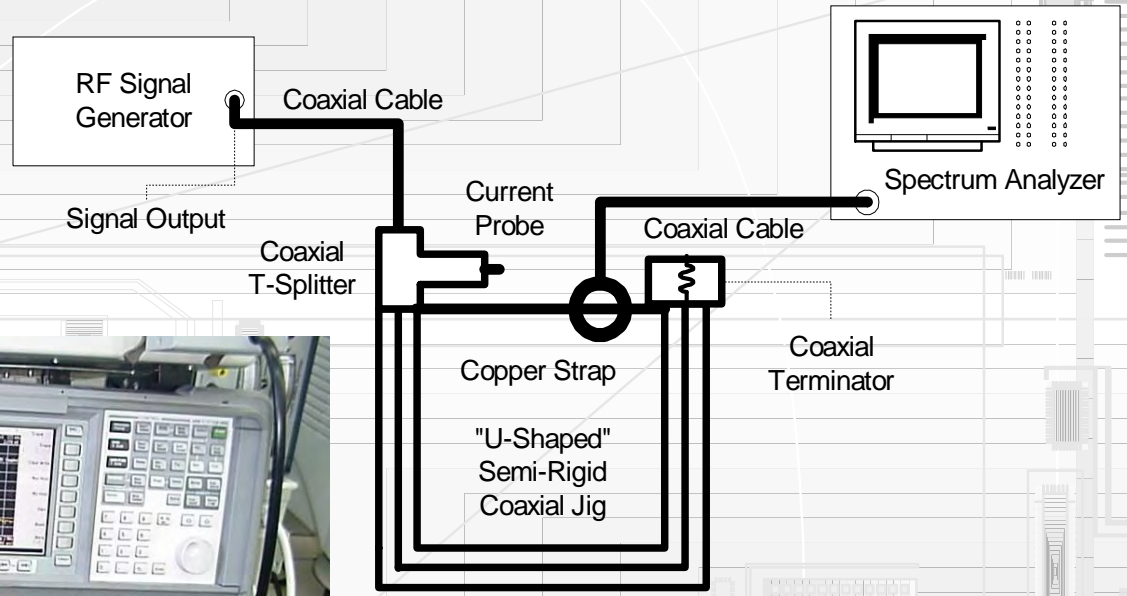

Where will the return current flow?

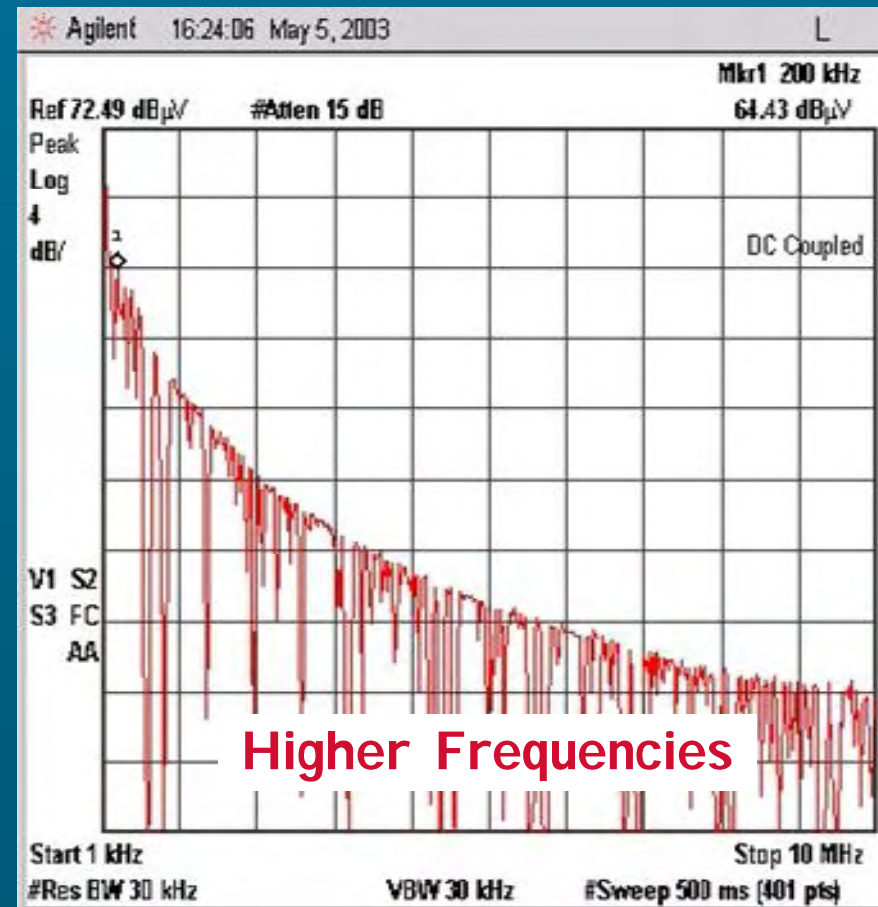
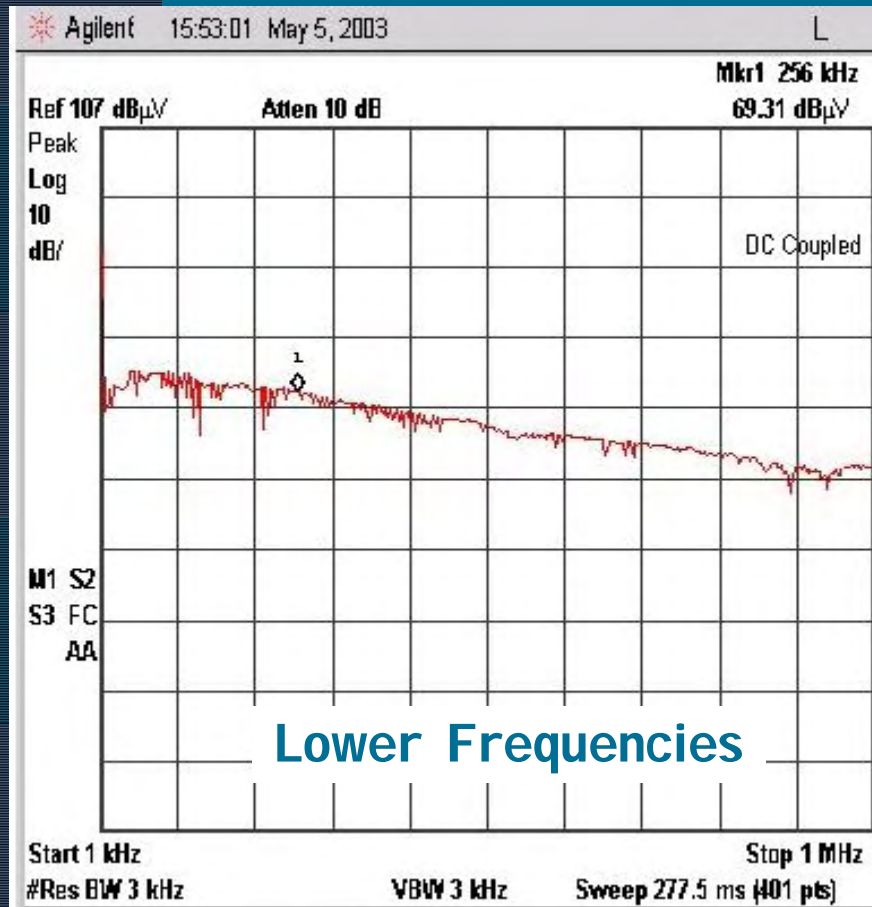

Where will the return current flow?

- Definition of Total Loop Inductance
- For $I, B = \text{constants}$, Φ_{\min} implies... A_{\min}

$$L = \frac{\phi}{I} \approx \frac{\int B \cdot d\vec{a}}{I}$$

$$\text{Thus: } L_{\min} \Leftrightarrow \phi_{\min} \Leftrightarrow A_{\min}$$

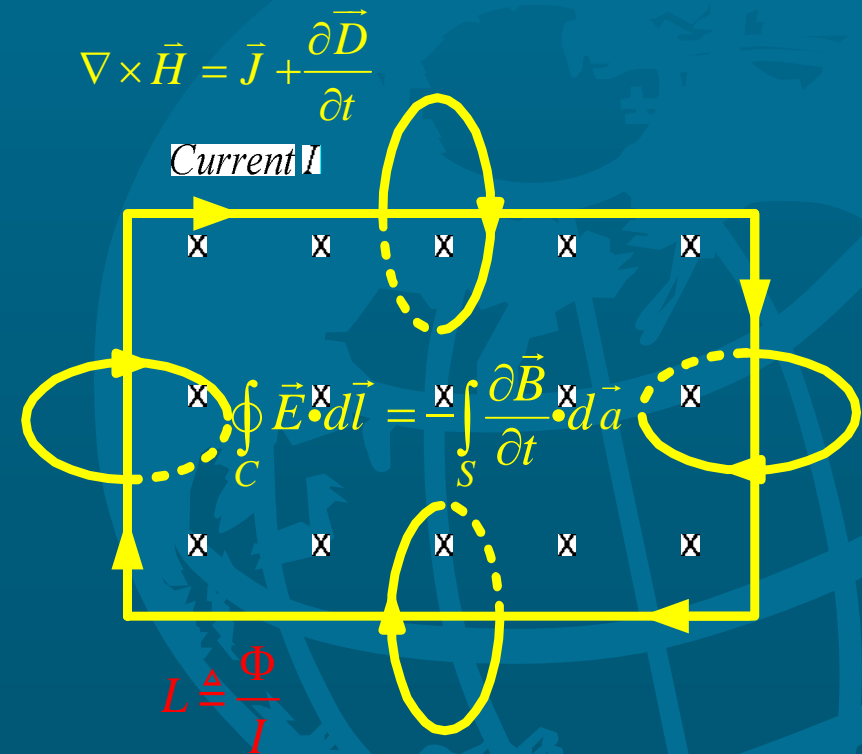

Balanced Wire Pairs

- Single (infinitely long) wire (?) carrying current...
- A closely spaced (infinitely long) wire pair (signal and return)

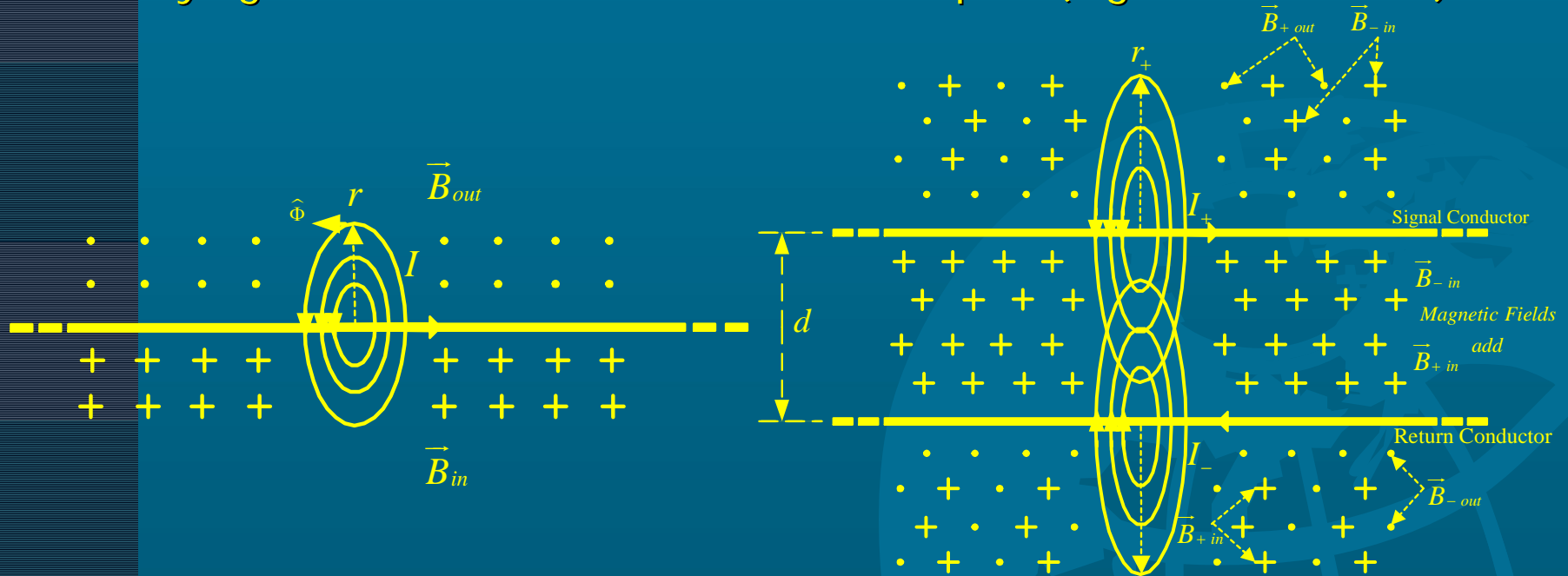

$$\frac{1}{\mu} (\nabla \times \vec{B}) = \vec{J} + \frac{\partial \vec{D}}{\partial t} \Rightarrow \vec{B} = \frac{\mu I}{2\pi r} \hat{\Phi}$$

$$\vec{B}_{Pair} = \vec{B}_{+in} - \vec{B}_{-in} = \frac{\mu I}{2\pi} \left(\frac{1}{r_+} - \frac{1}{r_-} \right) \hat{\Phi} \approx$$

Remember
Lower B → Lower E → Lower S

$$\approx \frac{\mu_0 I d}{2\pi r (r+d)} \hat{\Phi} \approx \frac{\mu_0 I d}{2\pi r^2} \hat{\Phi}$$

Twisted Wire Pairs

- Regular balanced wire pair (loop)
 - Some magnetic flux cancellation
 - Still large loop area

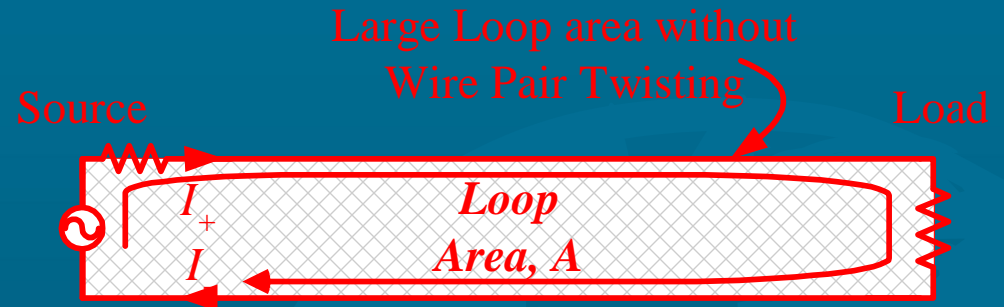

- Twisted balanced wire pair (loop)
 - Some magnetic flux cancellation
 - Still large loop area

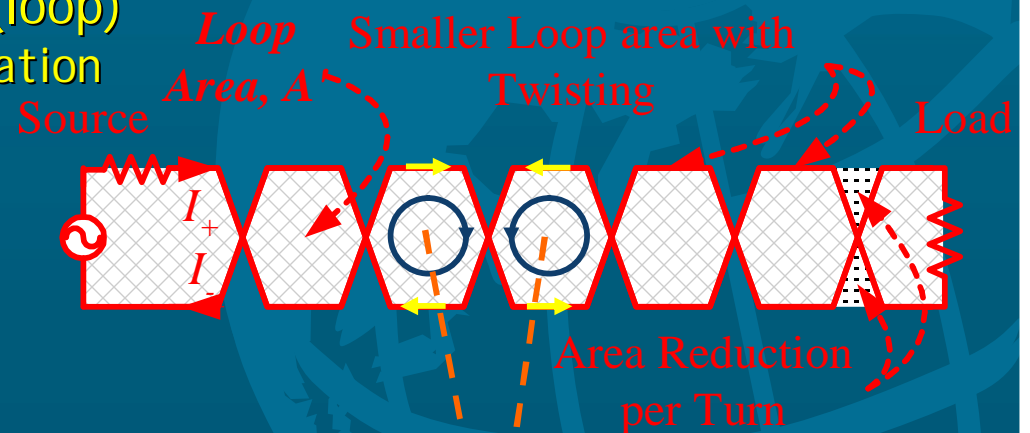

$$\vec{B}_{Pair} = \vec{B}_{+in} \hat{\Phi} - \vec{B}_{-in} \hat{\Phi}$$

Return Current Flow on PCBs

- Current flows in Trace & returning through plane
 - In reality, wave propagating in T-E-M mode between trace to return plane
 - E-Field (Faraday's Law)
 - H-Field (Ampere's Law)
 - Return plane is V_{CC} or GND
 - DC potential irrelevant
 - Boundary conditions prevail and dictate current distribution
 - E-Field (Gauss's Law)
 - H-Field (Ampere's Law)
 - Any gaps in return plane produce discontinuities
 - Return current remains on surface
 - E-field cannot exist in metal (Gauss's Law)
 - Some current flows in metal (Ohms Law in Materials)
 - Skin Effect in metal (Ampere's and Faraday's Law)

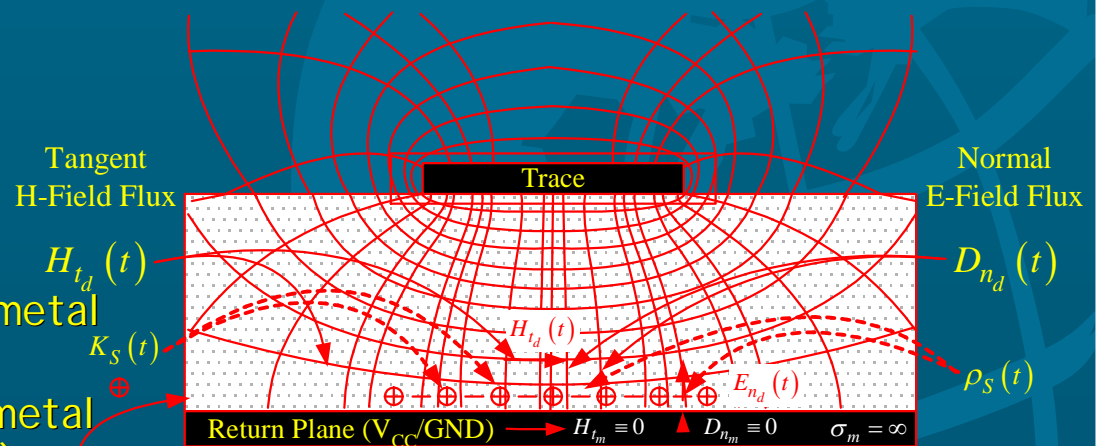

Return Current Flow on PCBs

- In a differential pair of traces most return RF current flows in plane and NOT in return conductor
 - Same boundary conditions occur
 - Between each trace to return plane
 - Some inter-trace coupling (weaker)
 - Same rules for trace routing should apply
 - Crossing gaps will produce emissions (Faraday's Law & Ampere's Law)
 - Differential characteristic impedance primarily dominated by Trace-Plane geometry
 - T-E-M propagation between Each trace to Plane (Faraday's Law & Ampere's Law)

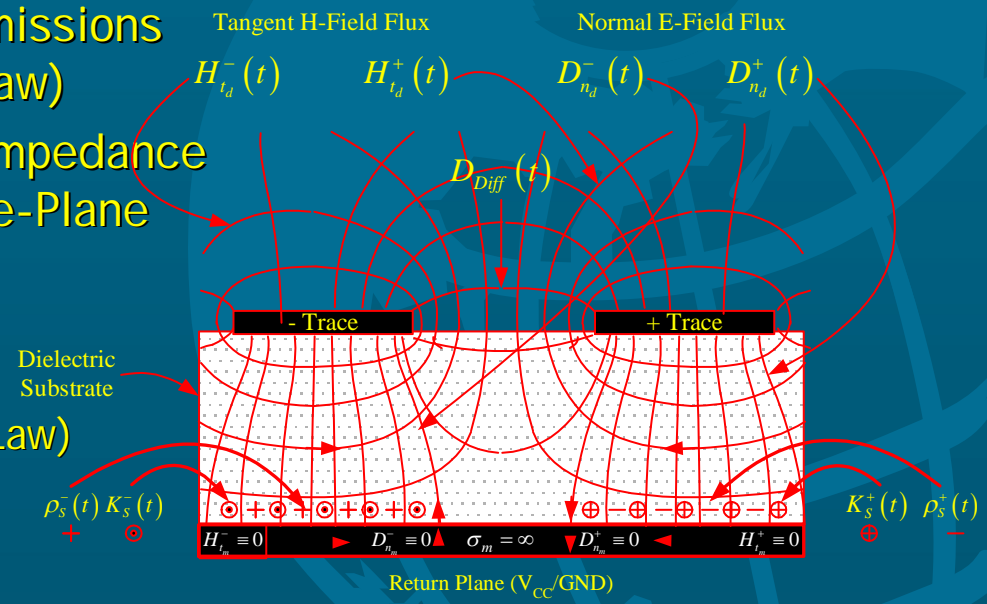

Summary

- The term Maxwell's equations nowadays applies to a set of four equations that were grouped together as a distinct set in 1884 by **Oliver Heaviside**, in conjunction with Willard Gibbs
- The importance of Maxwell's role in these equations lies in the correction he made to Ampere's circuital law in his 1861 paper ***On Physical Lines of Force***
 - Adding the displacement current term to Ampere's circuital law enabling him to derive the electromagnetic wave equation in his later 1865 paper ***A Dynamical Theory of the Electromagnetic Field*** and demonstrate the fact that light is an electromagnetic wave
 - Later confirmed experimentally by Heinrich Hertz in 1887
- Some say that these equations were originally called the ***Hertz-Heaviside equations*** but that Einstein for whatever reason later referred to them as the Maxwell-Hertz equations

$$\nabla \cdot \vec{D} = \rho$$

$$\nabla \cdot \vec{B} = 0$$

$$\nabla \times \vec{E} = -\frac{\partial \vec{B}}{\partial t}$$

$$\nabla \times \vec{H} = \vec{J} + \frac{\partial \vec{D}}{\partial t}$$

THE
LONDON, EDINBURGH AND DUBLIN
PHILOSOPHICAL MAGAZINE
AND
JOURNAL OF SCIENCE.
—
(FOURTH SERIES.)

MARCH 1861.

XXV. *On Physical Lines of Force.* By J. C. MAXWELL, Professor of Natural Philosophy in King's College, London*.

PART I.—*The Theory of Molecular Vortices applied to Magnetic Phenomena.*

IN all phenomena involving attractions or repulsions, or any forces depending on the relative position of bodies, we have to determine the magnitude and direction of the force which would act on a given body, if placed in a given position.

In the case of a body acted on by the gravitation of a sphere,

Summary

Maxwell's (8 !!!) Original Equations

(A) The law of total currents

- Conductive and displacement currents

$$\vec{J}_{Total} = \vec{J} + \frac{\partial \vec{D}}{\partial t}$$

(B) The equation of magnetic force

- Vector potential definition

$$\mu \vec{H} = \nabla \times \vec{A}$$

(C) Ampere's circuital law

$$\nabla \times \vec{H} = \vec{J}_{Total}$$

(D) EMF from convection, induction, and static electricity

- This is in effect the Lorentz force

$$\vec{E} = \mu \nu \times \vec{H} - \frac{\partial \vec{A}}{\partial t} - \nabla \Phi$$

(E) The electric elasticity equation

$$\vec{E} = \frac{1}{\epsilon} \vec{D}$$

(F) Ohm's law

$$\vec{E} = \frac{1}{\sigma} \vec{J}$$

(G) Gauss' law

$$\nabla \cdot \vec{D} = \rho$$

(H) Equation of continuity

$$\nabla \cdot \vec{J} = -\frac{\partial \rho}{\partial t}$$

Summary

"From a long view of the history of mankind - seen from, say, ten thousand years from now - there can be little doubt that the most significant event of the 19th century will be judged as Maxwell's discovery of the laws of electrodynamics.

"The American Civil War will pale into provincial insignificance in comparison with this important scientific event of the same decade"

(Richard P. Feynman)

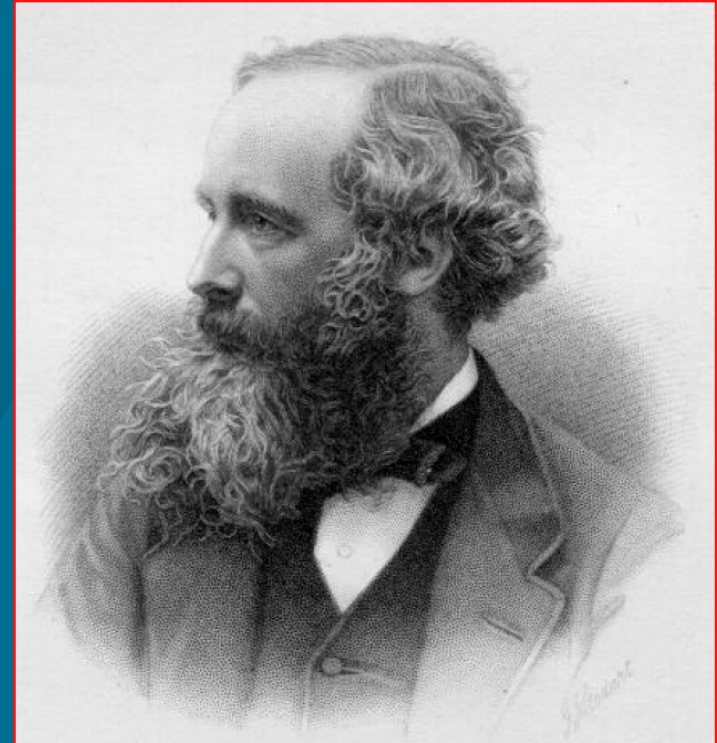

Maxwell's equations

The greatest equations ever

- Maxwell's equations of electromagnetism and the Euler equation top a poll to find the greatest equations of all time.
- **Although Maxwell's equations are relatively simple, they daringly reorganize our perception of nature, unifying electricity and magnetism and linking geometry, topology and physics**
- They are essential to understanding the surrounding world and as the first field equations, they not only showed scientists a new way of approaching physics but also took them on the first step towards a unification of the fundamental forces of nature

Epilog: Maxwell's Poetry

A Problem in Dynamics

An inextensible heavy chain
Lies on a smooth horizontal plane,
An impulsive force is applied at A,
Required the initial motion of K.

Let ds be the infinitesimal link,
Of which for the present we've only to think;
Let T be the tension, and $T + dT$
The same for the end that is nearest to B.
Let a be put, by a common convention,
For the angle at M 'twixt OX and the tension;
Let V_t and V_n be ds 's velocities,
Of which V_t along and V_n across it is;
Then V_n/V_t the tangent will equal,
Of the angle of starting worked out in the sequel.

In working the problem the first thing of course is
To equate the impressed and effectual forces.
 K is tugged by two tensions, whose difference dT
Must equal the element's mass into V_t .
 V_n must be due to the force perpendicular
To ds 's direction, which shows the particular
Advantage of using da to serve at your
Pleasure to estimate ds 's curvature.
For V_n into mass of a unit of chain
Must equal the curvature into the strain.

Thus managing cause and effect to discriminate,
The student must fruitlessly try to eliminate,
And painfully learn, that in order to do it, he
Must find the Equation of Continuity.
The reason is this, that the tough little element,
Which the force of impulsion to beat to a jelly meant,
Was endowed with a property incomprehensible,
And was "given," in the language of Shop, "inexten-sible."
It therefore with such pertinacity odd defied
The force which the length of the chain should have modified,
That its stubborn example may possibly yet recall
These overgrown rhymes to their prosody metrical.
The condition is got by resolving again,
According to axes assumed in the plane.
If then you reduce to the tangent and normal,
You will find the equation more neat tho' less formal.
The condition thus found after these preparations,
When duly combined with the former equations,
Will give you another, in which differentials
(When the chain forms a circle), become in essentials
No harder than those that we easily solve
In the time a T totum would take to revolve.

Now joyfully leaving ds to itself, a-
Tend to the values of T and of a .

James and Katherine
Maxwell, 1869



The chain undergoes a distorting convulsion,
Produced first at A by the force of impulsion.
In magnitude R , in direction tangential,
Equating this R to the form exponential,
Obtained for the tension when a is zero,
It will measure the tug, such a tug as the "hero
Plume-waving" experienced, tied to the chariot.
But when dragged by the heels his grim head could not carry aught,
So give a its due at the end of the chain,
And the tension ought there to be zero again.
From these two conditions we get three equations,
Which serve to determine the proper relations
Between the first impulse and each coefficient
In the form for the tension, and this is sufficient
To work out the problem, and then, if you choose,
You may turn it and twist it the Dons to amuse.

James Clerk Maxwell